



**Turbine**  
**Duo**

**CENTRIFUGAL PUMP**



Owner's Manual

Manuali dei Prodotti

用戶手冊

Bedienungsanleitung

Manual do Proprietário

使用說明書

Mode d'emploi

Instrukcja Obsługi



***Dear Customer,***

Thank you for purchasing this product.

For optimum performance and safety, please read these instructions carefully.

**User Memo:**

Date of purchase:	_____
Dealer name:	_____
Dealer address:	_____ _____
Dealer website:	_____
Dealer email:	_____
Dealer phone no.:	_____

**Please visit us on facebook or twitter!**



<https://www.facebook.com/Maxspect>



<http://twitter.com/maxspectled>

# Package Content

Please check the content in the package.

English

## Main Components

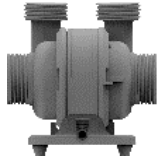

Pump Unit



Controller

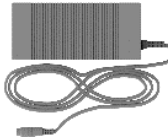

Power Supply Unit



Power Cable



Backup Battery  
Adaptar

## Inlet Spare Parts

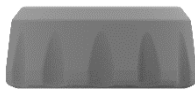

1.  $\Phi 58\text{mm}$  2pcs



2. 1" 2pcs



2A.  $\Phi 32\text{mm}$  2pcs



3.  $\Phi 40\text{mm}$  2pcs



4. 2pcs



5. 2pcs

## Duo Outlet Spare Parts

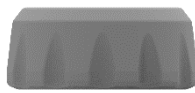

6.  $\Phi 51\text{mm}$  2pcs

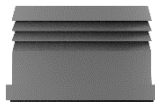

7.  $\frac{3}{4}$ " 2pcs

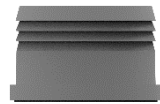

7A.  $\Phi 25\text{mm}$  2pcs



7B.  $\Phi 16\text{mm}/\frac{1}{2}$ " 2pcs  
 $\Phi 20\text{mm}/\frac{3}{4}$ " 2pcs



7C.  $\Phi 25\text{mm}/1$ " 2pcs  
 $\Phi 32\text{mm}/1\frac{1}{4}$ " 2pcs



8.  $\Phi 32\text{mm}$  2pcs

# Package Content

English

## Y-Tubing Spare Parts

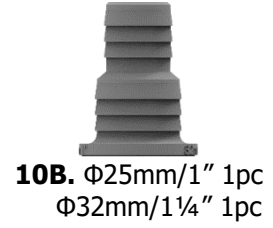
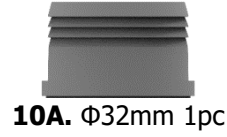
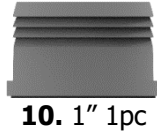
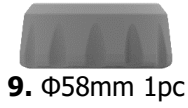

## Single Outlet Spare Parts

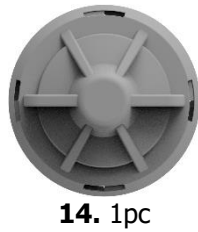

Before using this Maxspect™ Turbine Duo DC Pump please read these operating instructions carefully. Take special care to follow the safety suggestions listed below.

Afterwards keep this manual handy for future reference.

### READ AND FOLLOW ALL SAFETY INSTRUCTIONS

1. **DANGER** – To avoid possible electric shock, special care should be taken since water is employed in the use of aquarium equipment. For each of the following situations, do not attempt to repair by yourself; return the appliance to an authorized service facility for service or discard the appliance.
  - a) If the appliance shows any sign of abnormal water leakage, immediately unplug it from the power source.
  - b) Carefully examine the appliance after installation. It should not be plugged in if there is water on parts not intended to be wet.
  - c) Do not operate any appliance if it has a damaged cord or plug, or if it is malfunctioning or has been dropped or damaged in any manner.
  - d) To avoid the possibility of the appliance plug or receptacle getting wet, position aquarium stand and tank to one side of a wall-mounted receptacle to prevent water from dripping onto the receptacle or plug. A “drip-loop” shown in the figure, should be arranged by the user for each cord connecting an aquarium appliance to a receptacle. The “drip-loop” is that part of the cord below the level of the receptacle, or the connector if an extension cord is used, to prevent water traveling along the cord and coming in contact with the receptacle. If the plug or socket does get wet, DON'T unplug the cord. Disconnect the fuse or circuit breaker that supplies power to the appliance. Then unplug and examine for presence of water in the receptacle.

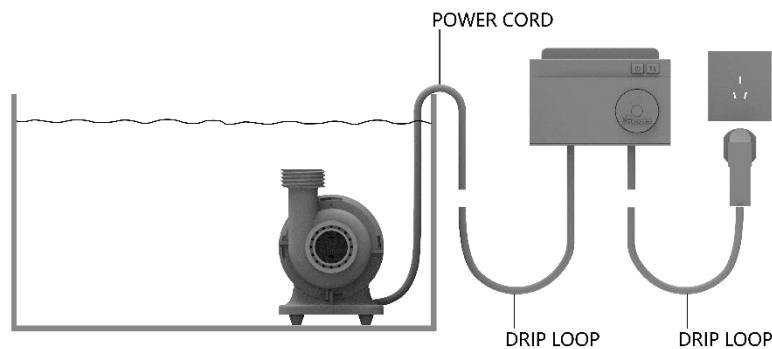

2. Close supervision is necessary when any appliance is used by or near children.
3. To avoid injury, do not contact moving parts or hot parts such as heaters, reflectors, lamp bulbs, and the like.

## Precautions

English

4. Always unplug an appliance from an outlet when not in use, before putting on or taking off parts, and before cleaning. Never yank cord to pull plug from outlet. Grasp the plug and pull to disconnect.
5. Do not use an appliance for other than intended use. The use of attachments not recommended or sold by the appliance manufacturer may cause an unsafe condition.
6. Do not install or store the appliances where it will be exposed to the weather or to temperatures below freezing.
7. Make sure an appliance mounted on a tank is securely installed before operating it.
8. Read and observe all the important notices on the appliance.
9. If an extension cord is necessary, a cord with a proper rating should be used. A cord rated for less amperes or watts than the appliance rating may overheat.
10. The power supply cords should be routed so that they are not likely to be walked on or pinched by items placed upon or against them. Never take hold of the plug or cord if your hand is wet, and always grasp the plug body when connecting or disconnecting it.
11. The appliance is designed to be used in the water ONLY, the entire body of the appliance must be submersed in the water.

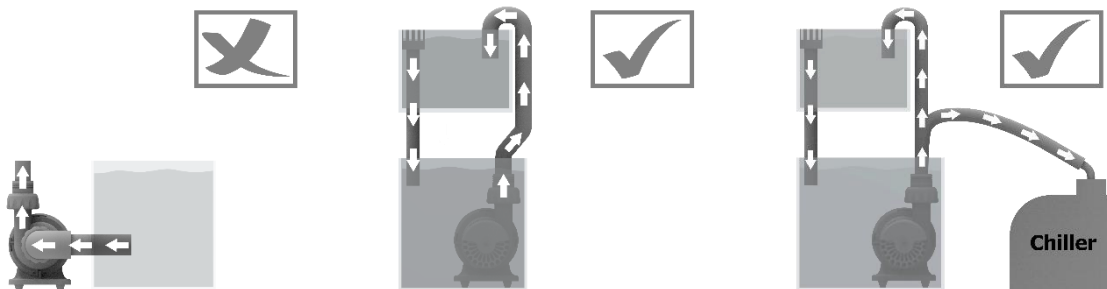

12. To maintain the good performance of the appliance, it should be installed where the vertical distance between the outlet and inlet is less than 6.5ft (2m).

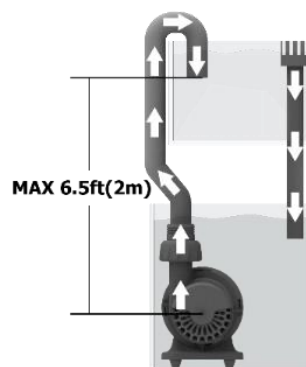

# Regular Pump Unit Maintenance

**English**

## Maintenance of the Appliance

Your Turbine Duo DC Pump is designed to operate optimally with little attention after initial setup. However, due to the harsh conditions of a saltwater aquarium and resulting buildup of algae and other organic matter, it is advisable to clean the pump to ensure the longevity of appliance. Maxspect recommends doing a cleaning every 6 months or as necessary. This can be accomplished by opening the impeller housing and gently brushing the impeller and inside of impeller housing with a soft brush under running water. If there is calcium buildup, it may be necessary to soak these parts in a mild acid solution such as vinegar. Do not use strong acids, because these may damage the components. After cleaning, reassemble the appliance.

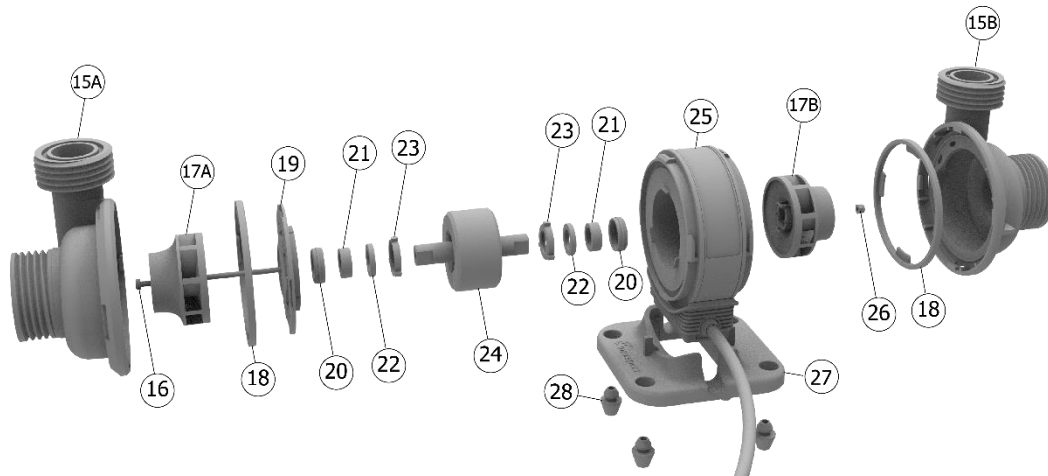

- |                          |                          |                 |                  |
|--------------------------|--------------------------|-----------------|------------------|
| 15A. Impeller Housing(A) | 15B. Impeller Housing(B) | 16. Screw       | 17A. Impeller(A) |
| 17B. Impeller(B)         | 18. Silicon Seal         | 19. Rotor Cover | 20. Silicon Pad  |
| 21. Bearing              | 22. Ceramic Bearing      | 23. Silicon Pad | 24. Rotor        |
| 25. Stator               | 26. Nut                  | 27. Pump Base   | 28. Silicon Pad  |



## Installation

### Inlet Installation

You can switch the union coupling between 2/2A to fit a different size pipe while Turbine Duo runs as a closed loop pump.

English

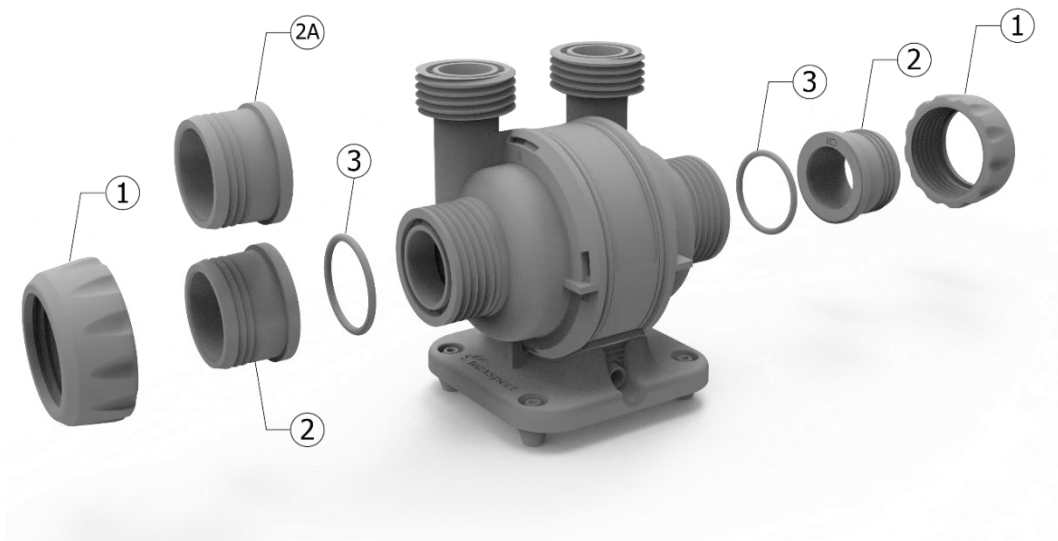

Or you can also install two intake grids while it runs as a return pump.

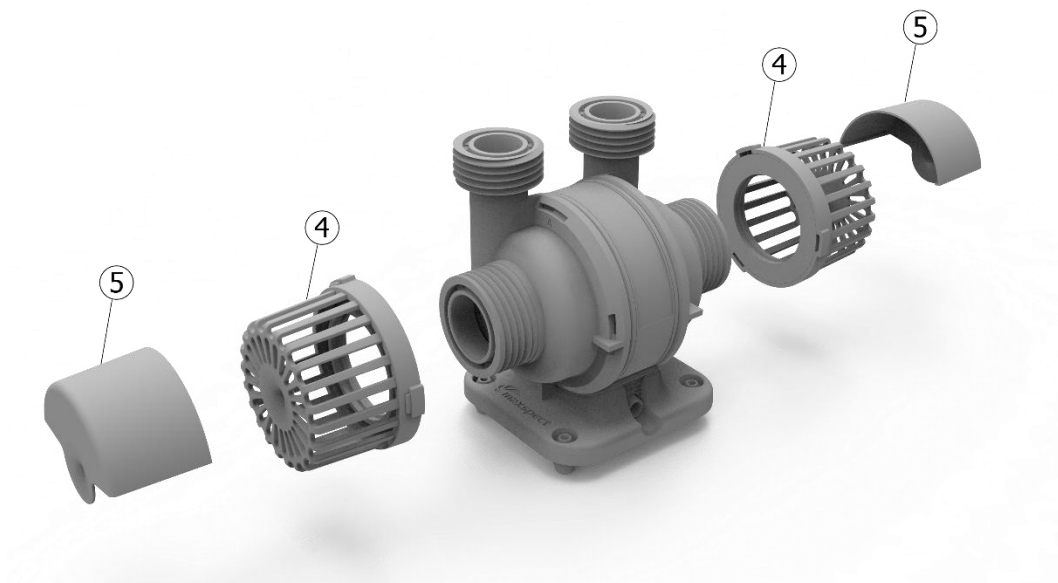

# Installation

## Outlet Installation

English

**Duo Outlets:** Switch the union couplings among 7/7A/7B/7C to a fit different size pipe or hose.

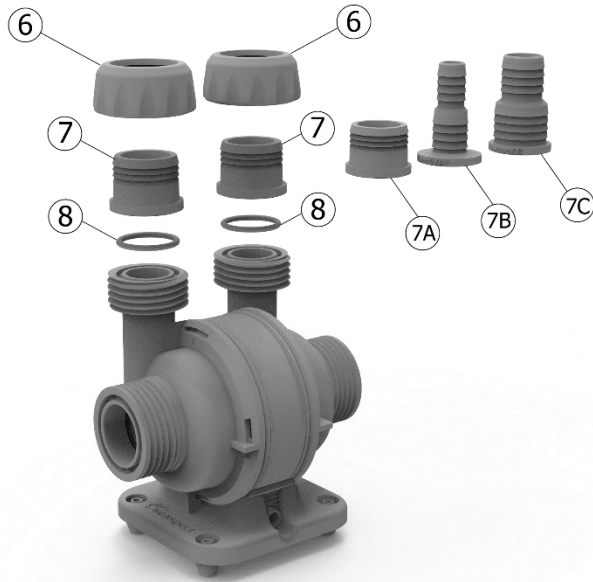

**Combined Outlet using Y-Tubing:** Switch the union couplings among 10/10A/10B to a fit different size pipe or hose.

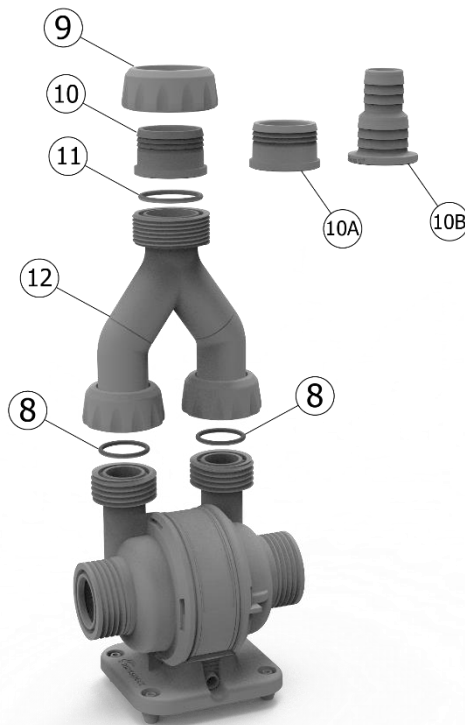

# Installation

English

**Single Outlet:** You can also replace the B impeller housing by the cap to make it a single outlet DC pump.

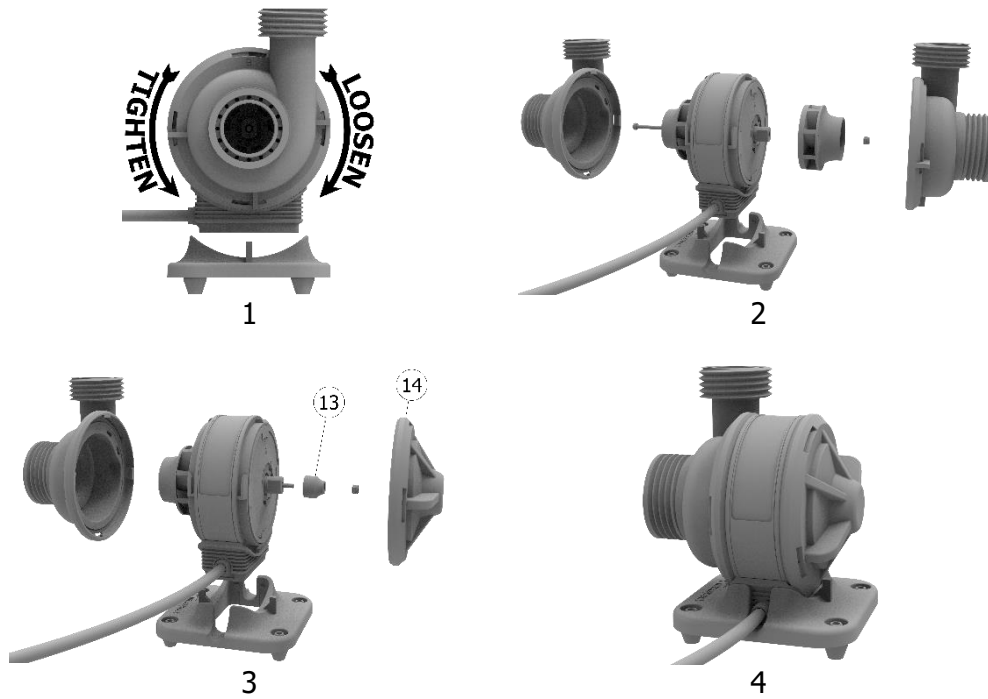

**Important: Only B impeller housing can be replaced by the cap.  
Pump Base must be installed before putting into use.**

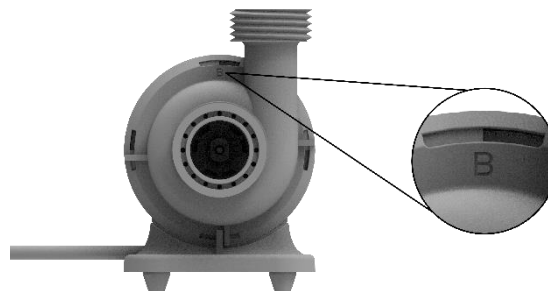

## Direction of Outlet

Both A and B impeller housings can be installed in three directions.



## The Turbine Duo Controller Unit

English

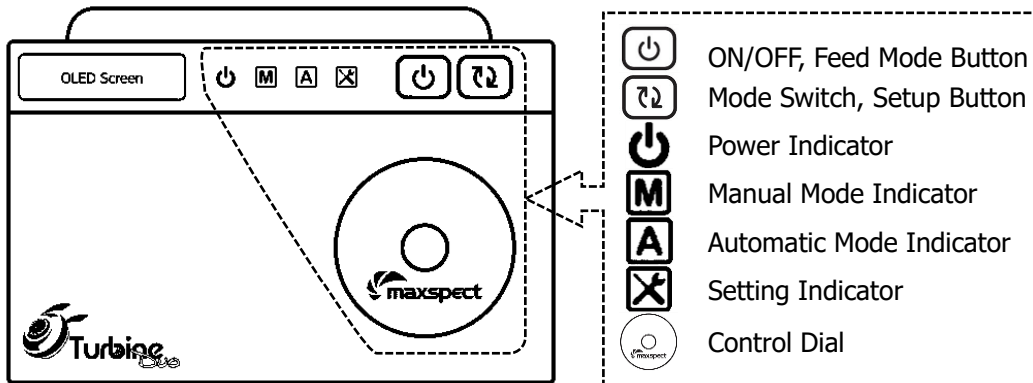

### Switch ON/OFF of the Turbine Duo

Press and hold the ON/OFF button over 4s can turn on or off the appliance. While the appliance is turned off, the pump will stop working, the indicators and OLED screen of the controller will be shut down. However, if the appliance is connected to an ICV6 (sold separately), it still can be activated by the Syna-G App.

### Initialize Your Turbine Duo

Before using the appliance, there are some basic setting you need to do for your Turbine Duo.

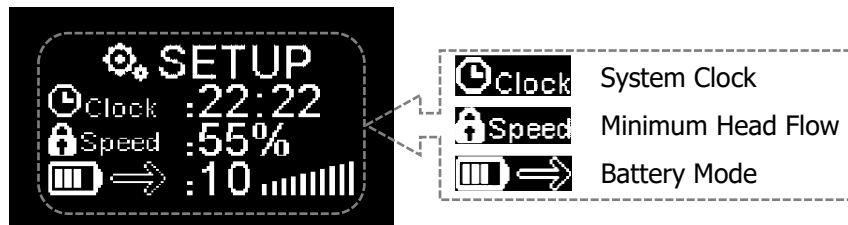

**Clock:** Set up the system clock to match with your local time.





**Speed:** Set up the minimum head flow for the pump of all time. It means the setting of minimum water flow for all water movement modes will be calculated based on this value. The adjustable minimum head flow range is between 1% and 90%.

**Battery Mode:** Set up the working speed of the pump while it is powered by a backup battery. The product is packed with a power switch adapter which featured with two power source cables, one end connects to the power supply unit offered by Maxspect, the other end connects to a DC12v battery (sold separately). When the power from the PSU is cut, the power source will be switched to the battery automatically.



# Operating Instructions

English

1. While the OLED screen is activated, press both  and  buttons simultaneously to enter the setup page.
2. Press  to switch between the settings.
3. Rotator  to set a value.
4. Press  to save the setting.



## Switching between Automatic and Manual Mode



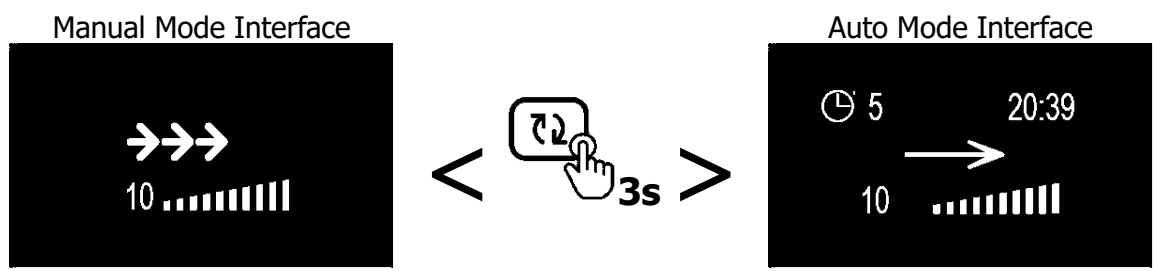

**Manual Mode:** Manually set a water movement mode and flow level for your Turbine Duo.  
**Auto Mode:** A set of programs with programmable water movement mode and flow level which will be cycled every 24hrs.



## Interface Introduction



Main Interface



-  5 Current Time Point
-  20:39 Current Time
-  Water Movement Mode
-  10 Flow Level
-  Level Indicator

Setting Page

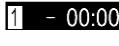

-  1 - 00:00 Time Point(Total 24)
-  Water Movement Mode
-  Configurable Variables

# Operating Instructions

## OLED Screen Icon

### Water Movement Modes



Constant Speed Mode



Pulsing Mode



Random Mode



Advanced Pulsing Mode

### Variables



Maximum Flow



Ramp Up Time



Maximum Flow Time



Minimum Flow



Wind Down Time



Minimum Flow Time

### Variables Illustration

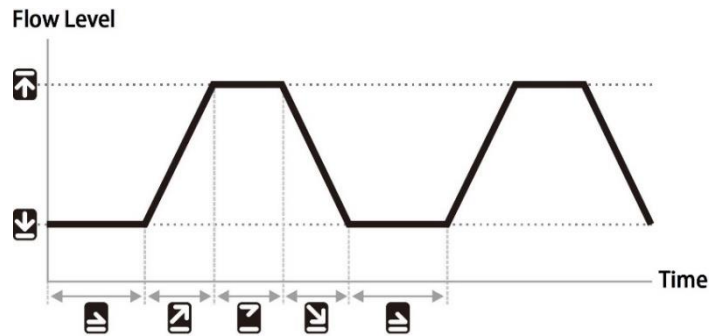

### Water Movement Mode Illustration



Constant Speed Mode

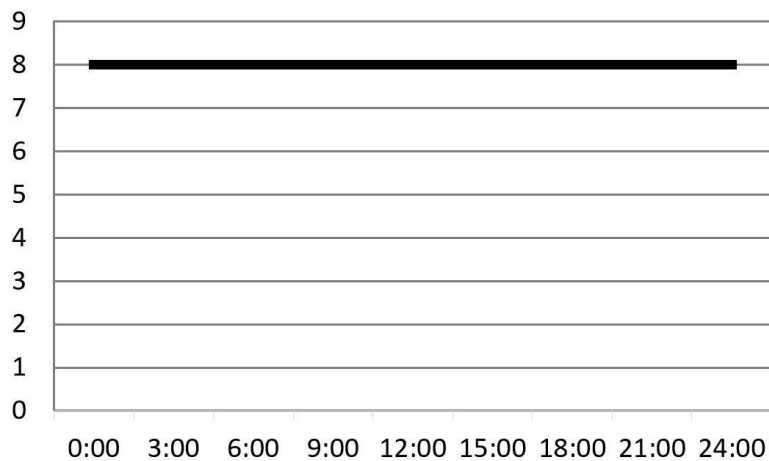

### Configurable Variables

Flow range: 1-10



Level 8



N/A



N/A



N/A



N/A



N/A

# Operating Instructions

English

## →→→ Pulsing Mode

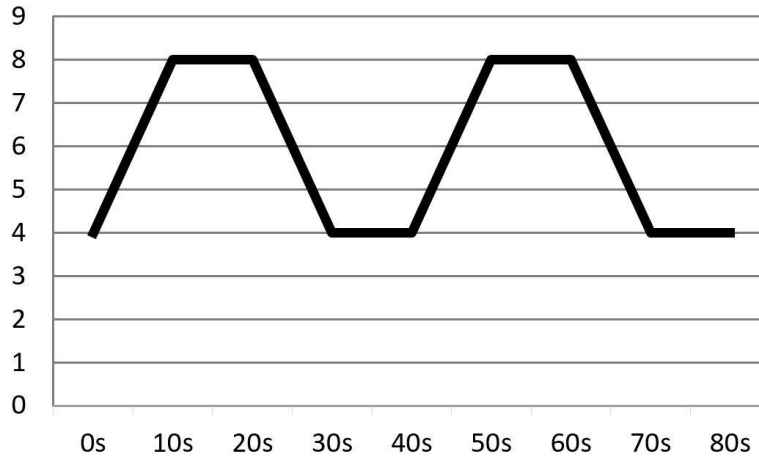

### Configurable Variables

Flow range: 1-10      Time range: 2-30s

↑	Level 8	↗	10s	↘	N/A
↓	Level 4	↙	N/A	↕	N/A
↗	=	↘	=	↙	=
↕	=	↕	=	↕	=
					10s

## →→→ Random Mode

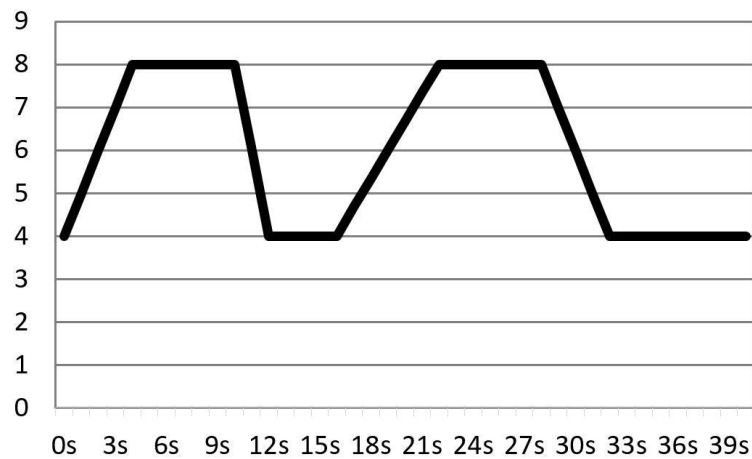

### Configurable Variables

Max flow range: 2-10, Min flow range: 1-9

↑	Level 8	↗	N/A	↘	N/A
↓	Level 4	↙	N/A	↕	N/A



## Advanced Pulsing Mode

English

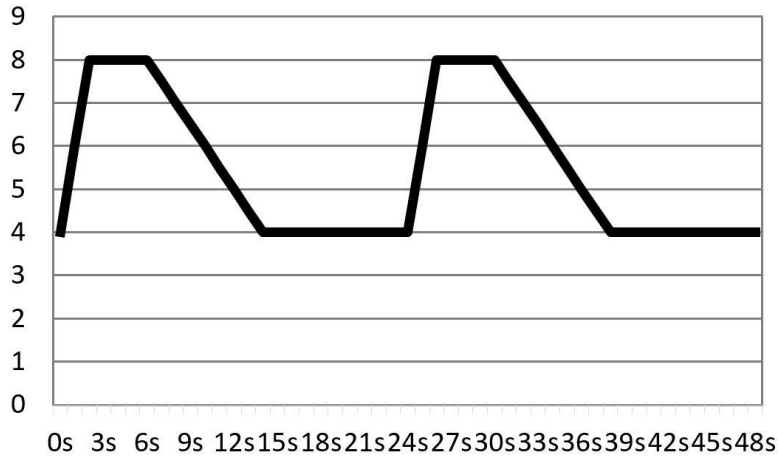

### Configurable Variables

Flow range: 1-10

Time range: 2s-5m



Level 8



2s



4s



Level 4



8s



20s

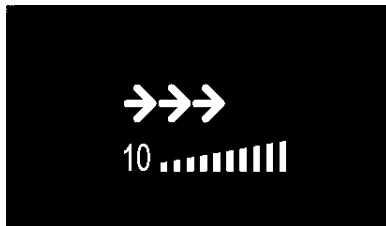

### Manual Mode

Main Interface

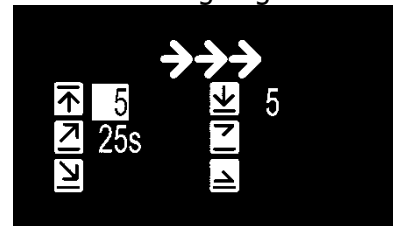

Setting Page



1. Press  to switch between the settings.
2. Rotator  to set a value.
3. Press  to save the setting.

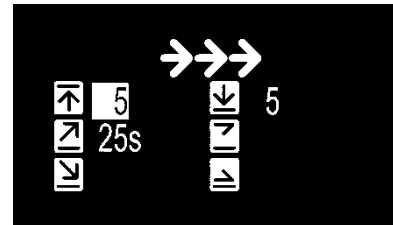





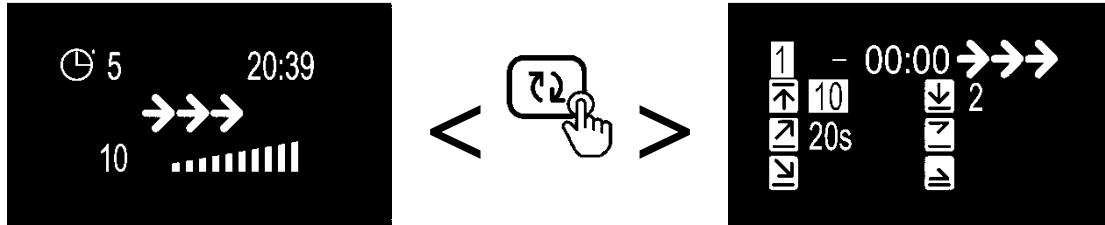

# Operating Instructions

English

## Automatic Mode





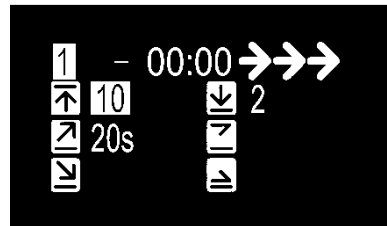

1. Press  to switch between the settings.
2. Rotator  to set a value.
3. Press  to save the setting.

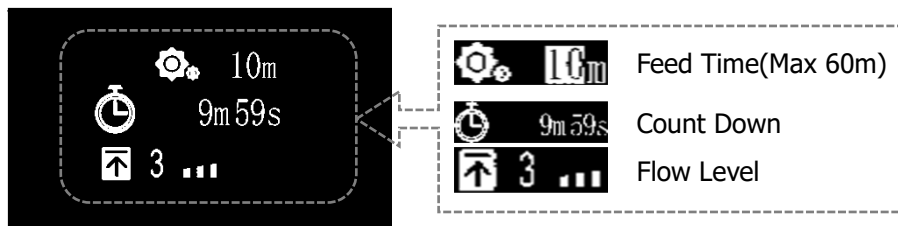

## Feed Mode



In either main interface, press  to enter Feed Mode.

1. Press  to activate the setting.
2. Press  to switch between the settings.
3. Rotator  to set a value.
4. Press  to save the setting.

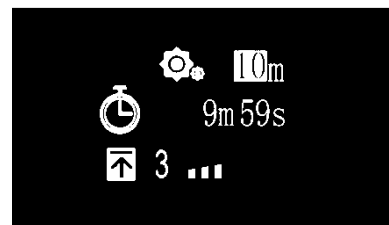

## Maintenance Instructions

### System Setup

English

System Setup features a set of functions allowing you to do perform maintenance on the appliance.

To enter the System Setup page, first turn off the appliance, then press and hold control dial while turning the appliance back on. Keep on holding the control dial until the system setup page is shown on OLED monitor.

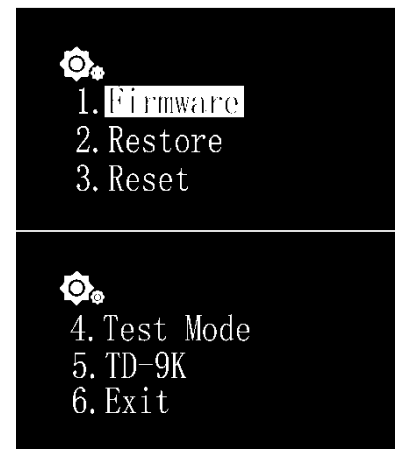

There are 5 functions in the System Setup screen.

1. Firmware
2. Restore
3. Reset
4. Test Mode
5. Model Number
6. Exit



#### 1. Firmware

This function allows you to update the firmware.

1. Rotate  to select "Firmware".
2. Press  to begin the firmware update.

1. When there is no micro SD card or invalid firmware in the micro SD card, "NO SD Card" or "Wrong File" will be shown on the screen.
2. Otherwise the firmware update progress will be shown.

Once the firmware has been updated successfully, the appliance will restart automatically and the new firmware version number will be shown on the screen.



## Maintenance Instructions

English

### 2. Restore



This function allows you to restore the firmware to its original factory version. After finish restoring the firmware, it'll restart automatically and the firmware version number will be shown on the screen.

1. Rotate  to select "Restore".
2. Press  to restore the firmware.



### 3. Reset

This function allows you to reset the appliance back to its factory settings. After finish resetting the appliance, it'll restart automatically.

1. Rotate  to select "Reset".
2. Press  to factory reset the appliance.





### 4. Test Mode

This function allows you to put the appliance in the test mode, which would help our customer service representative to diagnose the appliance. **This should only be done by the users when told by authorized dealer or customer representative to perform certain test on the appliance.**

### 5. Model Number

This function will display the model number of the fixture, which also double serves as the ID name when the Turbine Duo is connected to an iOS or Android device through the Syna-G system. **Under normal circumstances this value should not be changed.**

### 6. Exit

1. Rotate  to select "Exit".
2. Press  to factory restart the appliance.

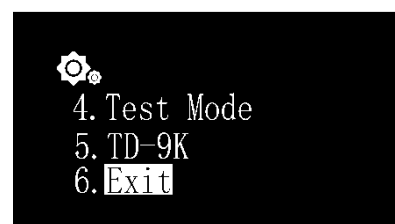

## Limited Warranty

Maxspect (HongKong) Limited warrants all Maxspect™ Turbine Duo DC pump products against defects in workmanship for a period of 12-months from the date of purchase. If a defect exists during the warranty period, Maxspect (HongKong) Limited at its option will either repair (using new or remanufactured parts) or replace (with a new or remanufactured unit) the product at no charge.

THE WARRANTY WILL NOT APPLY TO THE PRODUCT IF IT HAS BEEN DAMAGED BY MISUSE, ALTERATION, ACCIDENT, IMPROPER HANDLING OR OPERATION, OR IF UNAUTHORIZED REPAIRS ARE ATTEMPTED OR MADE. SOME EXAMPLES OF DAMAGES NOT COVERED BY WARRANTY INCLUDE, BUT ARE NOT LIMITED TO, USING AFTER-MARKET LED BULBS AND MODIFICATION OF THE CIRCUITRY, WHICH ARE PRESUMED TO BE DAMAGES RESULTING FROM MISUSE OR ABUSE.

### **DISCLAIMER OF CONSEQUENTIAL AND INCIDENTAL DAMAGES:**

You and any other user of Maxspect (HongKong) Limited products shall not be entitled to any consequential or incidental damages, including without limitation, loss of use of the unit, inconvenience, damage to personal property, phone calls, lost income or earnings. This warranty gives you specific legal rights and you may also have other rights, which vary from state to state.

MAXSPECT LTD. MAKES NO WARRANTY OR REPRESENTATION, EITHER EXPRESS OR IMPLIED, WITH RESPECT TO THE PRODUCT'S QUALITY, PERFORMANCE, MERCHANTABILITY, OR FITNESS FOR A PARTICULAR PURPOSE. AS A RESULT, THIS PRODUCT, IS SOLD "AS IS," AND YOU THE PURCHASER ASSUME THE ENTIRE RISK AS TO ITS QUALITY AND PERFORMANCE.

IN NO EVENT WILL MAXSPECT LTD BE LIABLE FOR DIRECT, INDIRECT, SPECIAL, INCIDENTAL, OR CONSEQUENTIAL DAMAGES RESULTING FROM ANY DEFECT IN THE PRODUCT OR ITS DOCUMENTATION.

The warranty, disclaimer, and remedies set forth above are exclusive and replace all others, oral or written, expressed or implied. At no time will any Maxspect (HongKong) Limited dealers, agents, or employees be authorized to make any modifications, extension, or addition to this warranty.

Some states do not allow the exclusion or limitation of implied warranties or liability for incidental or consequential damages, so the above limitation or exclusion may not apply to you.

## Specifications

For the latest specifications of Turbine Duo DC Pump, please visit: [www.maxspect.com](http://www.maxspect.com)



***Sehr geehrter Kunde,***

vielen Dank für den Kauf dieses Produkts.

Für eine optimale Leistung und Sicherheit, lesen Sie bitte diese Anleitung sorgfältig.

**Nutzer-Memo:**

Deutsch

Kaufdatum	_____
Händler:	_____
Händleradresse:	_____ _____
Händlerwebsite:	_____
Händler-E-Mail:	_____
Händlertelefon	_____

**Bitte besuchen Sie uns auf Facebook oder Twitter!**



<https://www.facebook.com/Maxspect>



<http://twitter.com/maxspectled>

## Packungsinhalt

**Bitte überprüfen Sie den Lieferumfang auf Vollständigkeit.**

### Hauptbestandteile

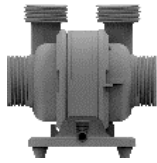

Pumpe



Steuereinheit

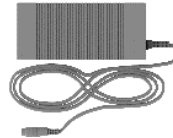

Netzteil



Stromkabel



Backup-Batterie-  
Adapter

Deutsch

### Pumpeneingangsteile

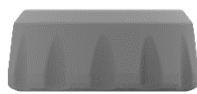

**1.** Φ58mm 2pcs

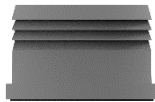

**2.** 1" 2pcs



**2A.** Φ32mm 2pcs



**3.** Φ40mm 2pcs



**4.** 2pcs

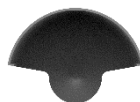

**5.** 2pcs

### Doppelpumpe-Auslassteile

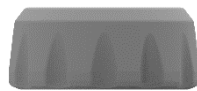

**6.** Φ51mm 2pcs

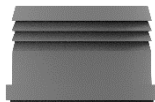

**7.** 3/4" 2pcs

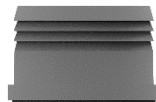

**7A.** Φ25mm 2pcs



**7B.** Φ16mm/1/2" 2pcs  
Φ20mm/ 3/4" 2pcs



**7C.** Φ25mm/1" 2pcs  
Φ32mm/1 1/4" 2pcs



**8.** Φ32mm 2pcs

**Y-Rohrteile**

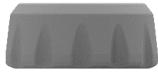

**9.**  $\Phi 58\text{mm}$  1pc

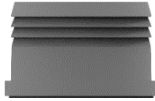

**10.** 1" 1pc



**10A.**  $\Phi 32\text{mm}$  1pc

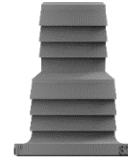

**10B.**  $\Phi 25\text{mm}/1''$  1pc  
 $\Phi 32\text{mm}/1\frac{1}{4}''$  1pc



**11.**  $\Phi 40\text{mm}$  1pc

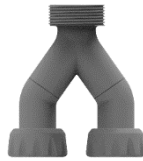

**12.** 1pc

**Einzelpumpe -Auslassteile**



**13.** 1pc



**14.** 1pc

Deutsch



## Sicherheitshinweise

Vor der ersten Inbetriebnahme des Maxspect™ DC pump Turbine Duo sollten Sie diese Bedienungsanleitung sorgfältig lesen. Bitte beachten Sie die folgenden Sicherheitshinweise mit großer Sorgfalt. Bewahren Sie diese Anleitung auch zum späteren Nachschlagen auf.

Deutsch

### LESEN UND FOLGEN SIE ALLE SICHERHEITSHINWEISE

1. **GEFAHR** - Um einen möglichen elektrischen Schlag zu vermeiden, sollte besondere Vorsicht geboten werden, da Wasser bei der Verwendung von Aquariengeräten eingesetzt wird. Für jede der folgenden Situationen, versuche nicht, selbst zu reparieren; Bringen Sie das Gerät an eine autorisierte Kundendienststelle zurück oder werfen Sie das Gerät.
  - a) Wenn das Gerät irgendwelche Anzeichen einer anormalen Wasserleckage aufweist, ziehen Sie es sofort aus der Stromquelle.
  - b) Das Gerät nach der Installation sorgfältig prüfen. Es sollte nicht eingesteckt werden, wenn es Wasser auf nicht beabsichtigte Teile gibt.
  - c) Betreiben Sie das Gerät nicht, wenn es beschädigtes Kabel oder Stecker hat oder wenn es fehlerhaft ist oder in irgendeiner Weise fallengelassen oder beschädigt wurde.
  - d) Um die Möglichkeit zu vermeiden, dass der Gerätestecker oder die Steckdose nass wird, positionieren Sie den Aquarienständer und den Tank auf eine Seite einer Wandsteckdose, um zu verhindern, dass Wasser auf die Steckdose oder den Stopfen tropft. Eine "Drip-Loop", die in der Abbildung gezeigt wird, sollte vom Benutzer für jede Schnur angeordnet werden, die ein Aquariumgerät mit einer Steckdose verbindet. Die "Tropfschleife" ist der Teil des Kabels unterhalb des Niveaus des Behälters oder der Stecker, wenn ein Verlängerungskabel verwendet wird, um zu verhindern, dass Wasser entlang der Schnur fährt und mit dem Behälter in Berührung kommt. Wenn der Stecker oder die Steckdose nass wird, ziehen Sie den Netzstecker nicht ab. Trennen Sie die Sicherung oder den Schutzschalter, der das Gerät mit Strom versorgt. Dann trennen und prüfen auf Vorhandensein von Wasser in der Steckdose.

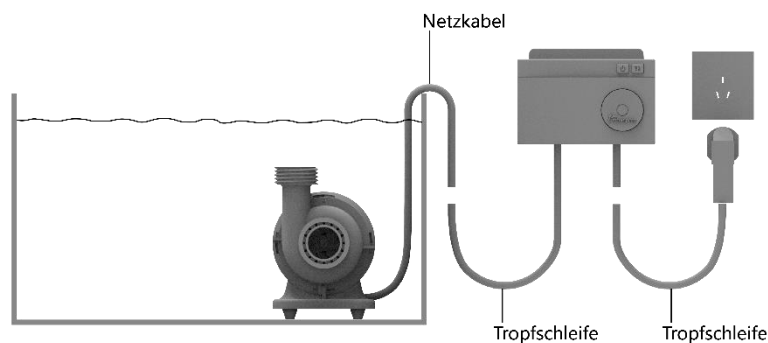

2. Die Überwachung ist erforderlich, wenn ein Gerät von oder in der Nähe von Kindern benutzt wird.
3. Um Verletzungen zu vermeiden, wenden Sie sich nicht an bewegliche Teile oder heiße Teile wie Heizkörper, Reflektoren, Lampenkolben und dergleichen.

## Sicherheitshinweise

4. Ziehen Sie das Gerät immer aus der Steckdose, bevor Sie es benutzen, bevor Sie es anziehen oder abnehmen, bevor Sie es reinigen. Niemals das Kabel ziehen, um den Stecker aus der Steckdose zu ziehen. Fassen Sie den Stecker an und ziehen Sie ihn abziehen
5. Verwenden Sie kein Gerät für andere als den vorgesehenen Gebrauch. Die Verwendung von Anhängen, die vom Gerätehersteller nicht empfohlen oder verkauft werden, kann zu einem unsicheren Zustand führen.
6. Installieren oder lagern Sie die Geräte nicht dort, wo sie dem Wetter ausgesetzt sind, oder Temperaturen unter dem Gefrierpunkt.
7. Stellen Sie sicher, dass ein Gerät, das an einem Tank montiert ist, vor dem Betrieb sicher installiert ist.
8. Lesen und beachten Sie alle wichtigen Hinweise auf dem Gerät.
9. Wenn ein Verlängerungskabel erforderlich ist, sollte ein Netzkabel mit einer korrekten Bewertung verwendet werden. Ein Kabel, das für weniger Ampere oder Watt als das Gerät bewertet wird, kann überhitzen.
10. Die Stromversorgungskabel sollten so verlegt werden, dass sie nicht wahrscheinlich auf Gegenstände gelegt oder eingeklemmt werden. Nehmen Sie niemals den Stecker oder das Kabel, wenn Ihre Hand nass ist, und greifen Sie immer den Stecker Körper beim Anschließen oder Trennen.
11. Die Pumpe wurde so konzipiert, dass sie NUR im Wasser verwendet werden kann. Deswegen muss der gesamte Körper der Pumpe GANZ im Wasser eingetaucht sein.

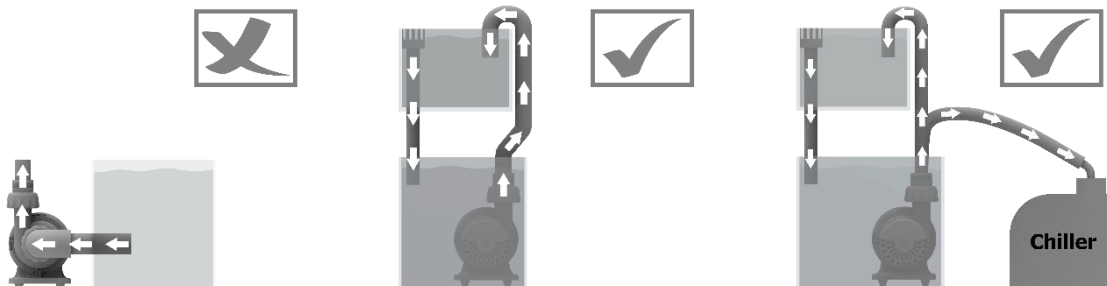

12. Um die optimale Leistung der Pumpe zu erzielen, sollte der vertikale Abstand zwischen dem Auslass und Einlass der Pumpe nicht mehr als 2 Meter betragen.

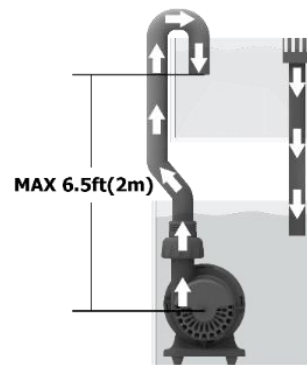

## Regelmäßige Wartung der Pumpeneinheit

### Wartung der Pumpe

Ihre Gleichstrom Pumpe, Turbine Duo, ist so konzipiert dass sie optimal mit wenig Aufmerksamkeit, nach der Ersteinrichtung, funktioniert. Jedoch, aufgrund der harten Bedingungen in Salzwasseraquarien und der Ansammlung von Algen und anderen organischen Stoffen, ist es sehr ratsam, die Pumpe zu reinigen um seine Langlebigkeit zu gewährleisten. Aus diesem Grund, empfiehlt Maxspect die Pumpe mindestens alle 6 Monate oder bei Bedarf auch öfter zu reinigen. Dafür, ist es notwendig, die Pumpe auseinander zu bauen und dann mittels einer weichen Bürste, das Schaufelrad sowie das Inneren des Körpers der Pumpe, unter fließendem Wasser, sanft reinigen. Bei Kalkablagerungen, können die Teile in einer Lösung aus Wasser und Essig eingeweicht werden. Verwenden Sie keine starken Säuren oder andere Reinigungsmittel, da dies die Komponenten beschädigen könnte. Nach der Reinigung das Gerät wieder zusammenbauen.

Deutsch

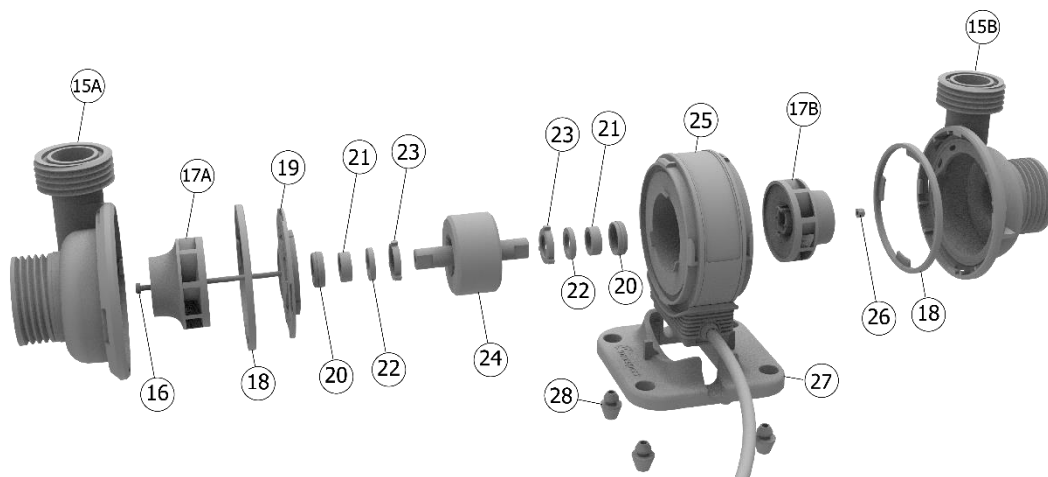

- |                             |                             |                    |                      |
|-----------------------------|-----------------------------|--------------------|----------------------|
| 15A. Schaufelradgehäuse (A) | 15B. Schaufelradgehäuse (B) | 16. Schraube       | 17A. Schaufelrad (A) |
| 17B. Schaufelrad (B)        | 18. Silikondichtung         | 19. Rotorabdeckung | 20. Silikonauflage   |
| 21. Lager                   | 22. Keramiklager            | 23. Silikonauflage | 24. Rotor            |
| 25. Stator                  | 26. Schraubenmutter         | 27. Pumpenbasis    | 28. Silikonauflage   |

## Einlassinstallation

Bei Verwendung der Turbine Duo Pumpe in einem geschlossenem System, können die Anschlusskupplung 2 oder 2A, je nach Durchmesser der Röhren oder Schläuchen, eingesetzt werden

Deutsch

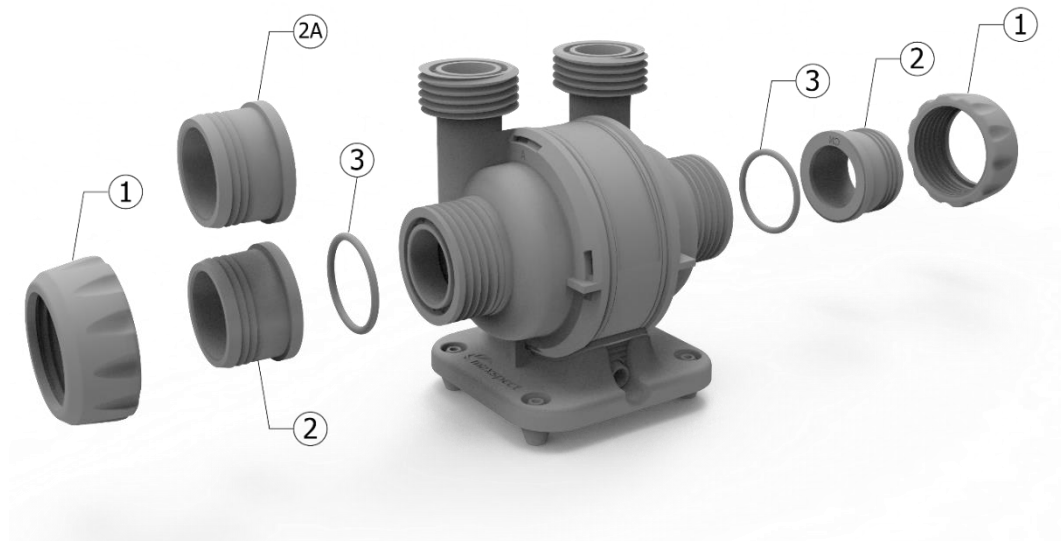

Bei Verwendung der Turbine Duo Pumpe als Rücklaufpumpe, können die zwei Einlaufgitter installiert werden.

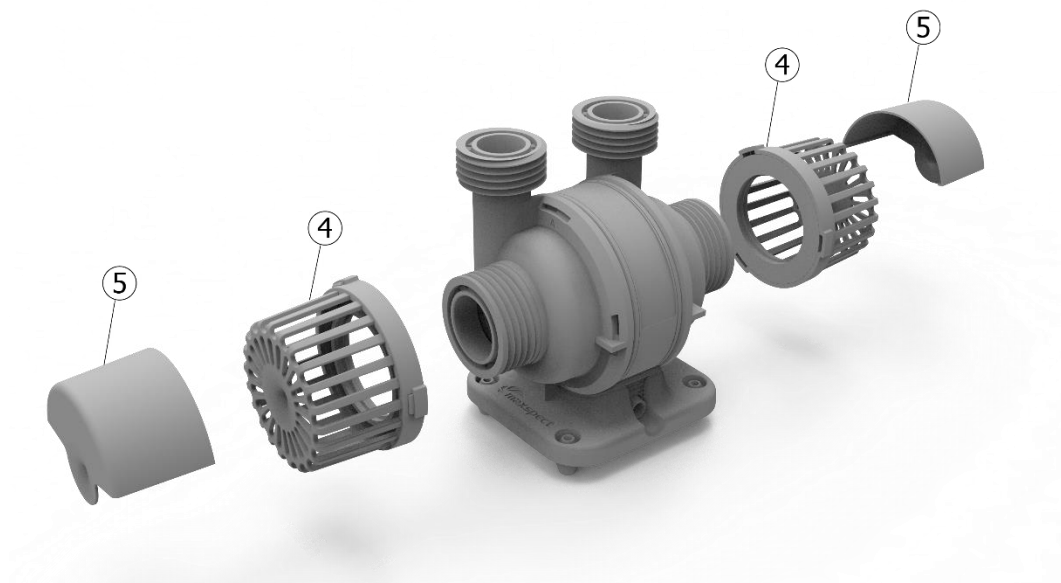

## Ausganginstallation

**Doppelausgang:** Bei Verwendung der Turbine Duo Pumpe mit den Doppelausgängen, können die Anschlusskupplung 7 / 7A / 7B / 7C, je nach Durchmesser der Röhren oder Schläuchen, eingesetzt werden.

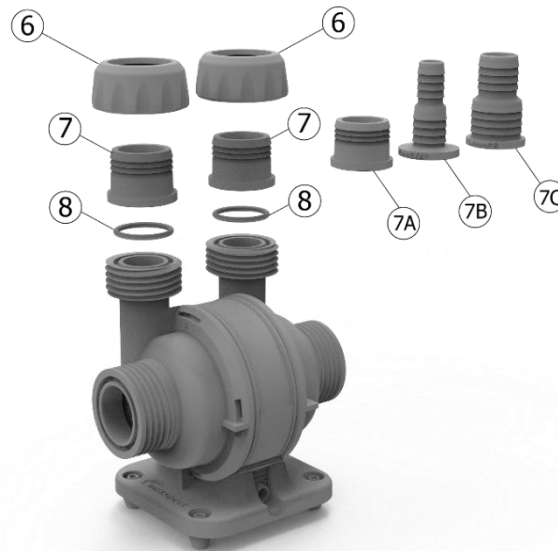

Deutsch

**Gekoppelter Auslass mit Y-Rohr:** Bei Verwendung der Turbine Duo Pumpe mit dem Y-Rohr, können die Anschlusskupplung 10 / 10A / 10B, je nach Durchmesser der Röhren oder Schläuchen, eingesetzt werden.

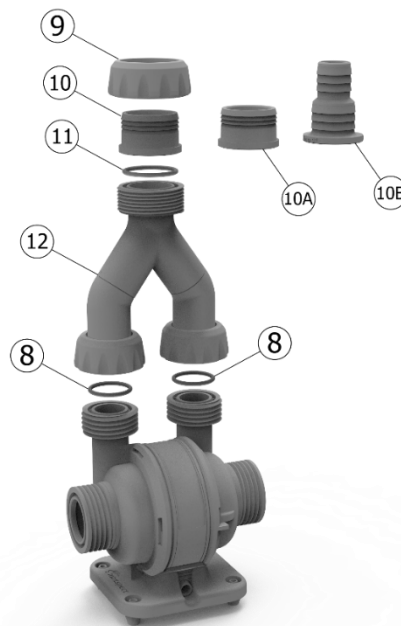

**Einzelauslass:** Bei Verwendung der Turbine Duo Pumpe mit nur einem Auslass, muss das B-Laufradgehäuse durch die Abdeckung 14 ersetzt werden.

Deutsch

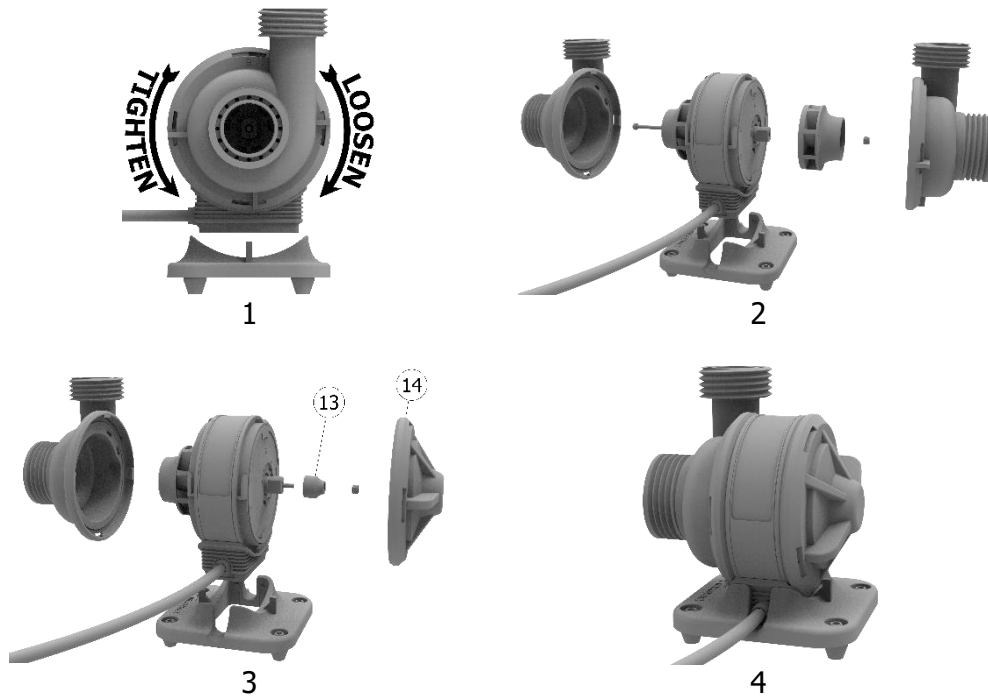

**Wichtig:** Nur das B-Laufradgehäuse kann durch die Abdeckung 14 ersetzt werden. Die Pumpenbasis muss vor Inbetriebnahme wieder installiert werden.

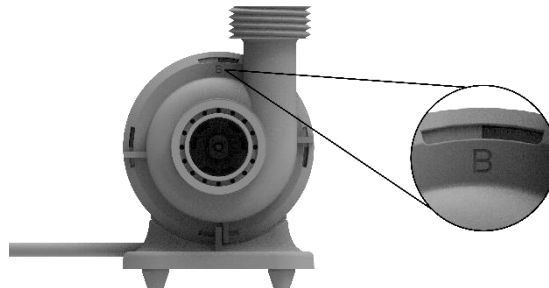

## Richtung der Auslässe

Die Laufradgehäuse A und B können in drei Richtungen eingerichtet werden.



# Bedienungsanleitung

## Die Turbine Duo Steuereinheit

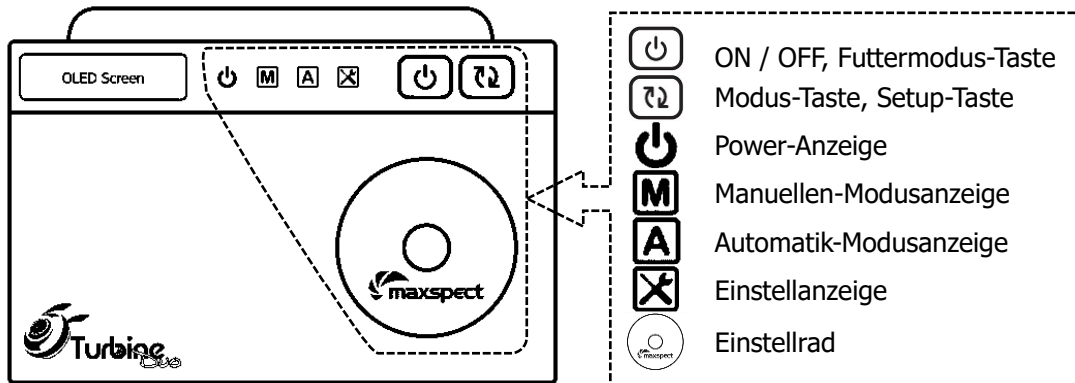

Deutsch

## Ein- / Ausschalten der Turbine Duo

Die ON / OFF-Taste 4s lang gedrückt halten um die Pumpe ein- oder ausschalten. Wurde ausschalten gewählt, schalten sich die Pumpe, sowie die Anzeigen und der OLED-Bildschirm der Steuereinheitlers, aus. Wenn die Pumpe jedoch über einen ICV6 angeschlossen ist (separat erhältlich), kann diese trotzdem über die Syna-G App gesteuert werden.

## Einrichtung der Turbine Duo

Vor Nutzung der Pumpe, sind einige grundlegende Einstellungen für die Turbine Duo vorzunehmen.

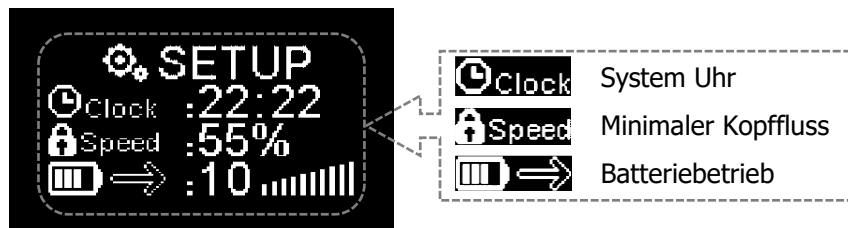





**Uhr:** Stellen Sie die Systemuhr so ein, dass sie mit Ihrer Ortszeit übereinstimmt.

**Speed:** Einstellung des permanenten Mindestdurchfluss der Pumpe. Diese Einstellung wird unter allen Umständen angewendet. Der Mindestdurchfluss kann von 1% bis 90% eingestellt wird.

**Batteriebetrieb:** Einstellung des Pumpendurchfluss wenn sie per Batterie betrieben wird. Die Pumpe wird mit einem Schaltnetzteil -Adapter geliefert, der mit zwei Stromquellenkabeln ausgestattet ist. Ein Kabel wird an das mitgelieferte Netzteil angeschlossen, das andere Kabel kann an einer DC12v Batterie (separat erhältlich) angeschlossen werden. Wenn die Stromversorgung des Netzteils abgeschnitten wird, wird die Stromquelle automatisch auf die Batterie geschaltet. Gibt es keine Stromversorgung mehr am Netzteil, wird automatisch die Pumpe an die Batterie geschaltet.



# Bedienungsanleitung

1. Während der OLED-Bildschirm aktiviert ist, um die Setup-Seite aufzurufen, gleichzeitig die Tasten  und , drücken.
2. Um zwischen den Einstellungen zu wechseln auf  drücken.
3. Den Drehknopf drehen  um einen Wert einzustellen.
4. Auf die Taste  drücken, um die Einstellung zu speichern.



Deutsch

## Umschalten zwischen Automatik- und Manuellen-Modus

**Manueller Modus:** Manuelles Einstellen des Wasserbewegungsmodus und der Ausgangsleistung für die Turbine Duo Pumpe.

**Auto-Modus:** Unterschiedliche Einstellungen mit programmierbarem wasser bewegungsmodus und der Ausgangsleistung für einen 24 Stunden Zyklus.

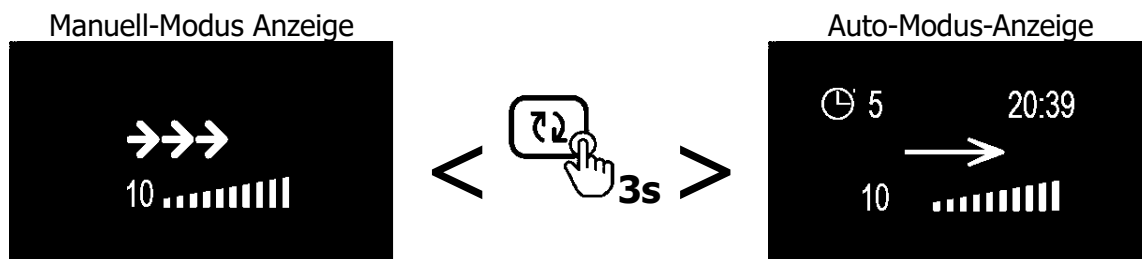

## Einführungsanzeige

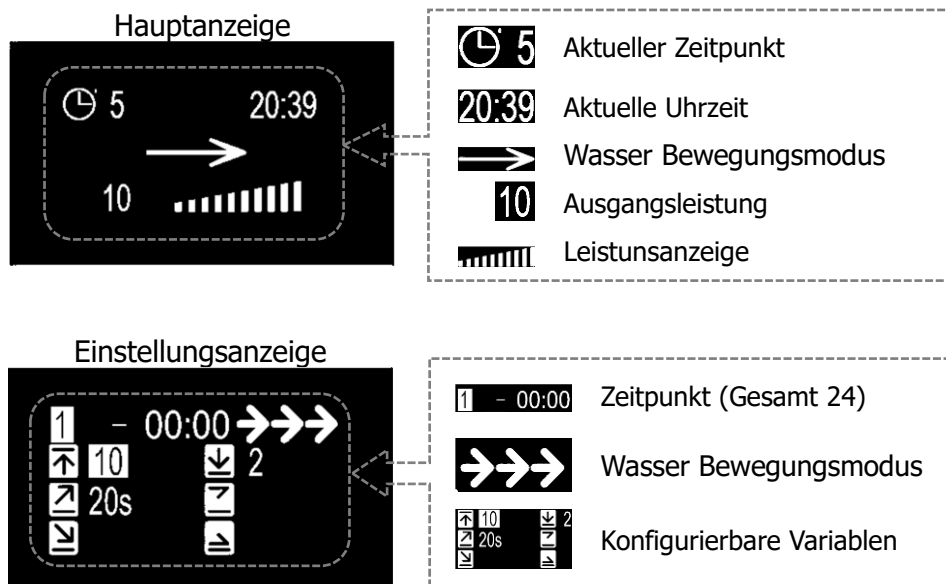



# Bedienungsanleitung

## OLED Screen Icon

### Wasser Bewegungsmodus



Permanent Strömungsmodus



Pulsierender Modus



Zufallsmodus



Erweiterten Pulsier Modus

### Variablen



Maximaler Fluß



Anstiegszeit



Maximale Fließzeit



Mindestdurchfluss



Abstiegszeit



Minimale Fließzeit

Deutsch

### Dargestellten Verfahren

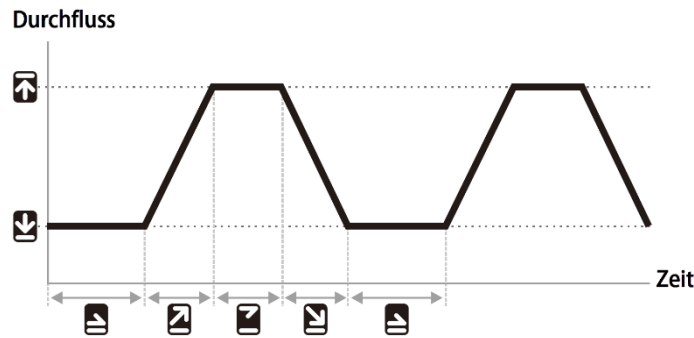

### Wasserbewegungsabbildung



Permanent Strömungsmodus

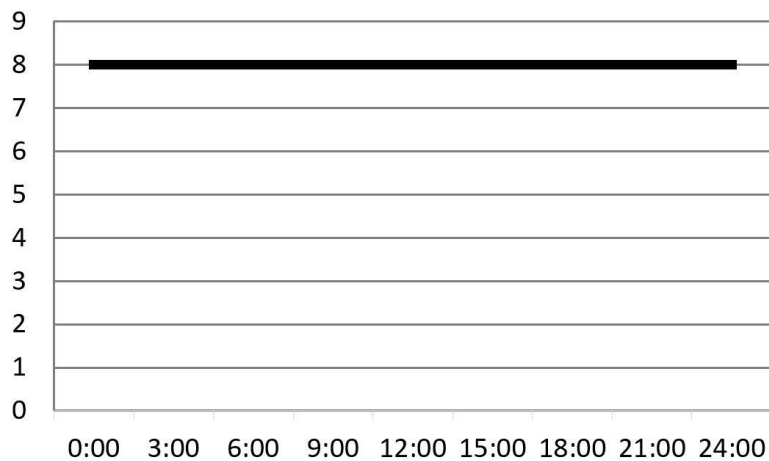

### Konfigurierbare Variablen

Durchflussbereich: 1-10



Ebene 8



N/A



N/A



N/A



N/A



N/A



## Pulsierender Modus

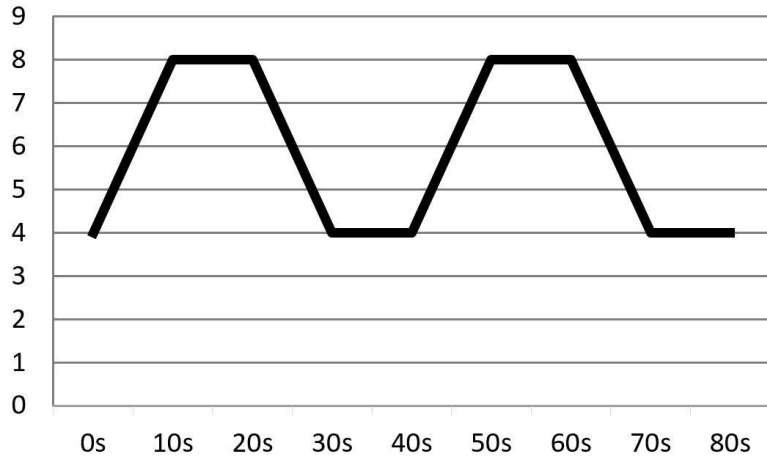

### Konfigurierbare Variablen

Durchflussbereich: 1-10

Zeitbereich: 2-30s



Ebene 8



10s



N/A



Ebene 4



N/A



N/A

= = = = 10s



## Zufallsmodus

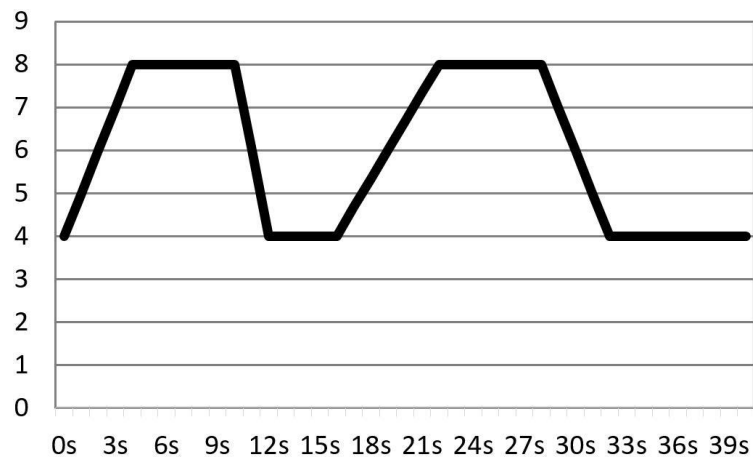

### Konfigurierbare Variablen

Max Durchflussbereich: 2-10, Min Durchflussbereich: 1-9



Ebene 8



N/A



N/A



Ebene 4



N/A



N/A

# Bedienungsanleitung



## Erweiterten Pulsier Modus

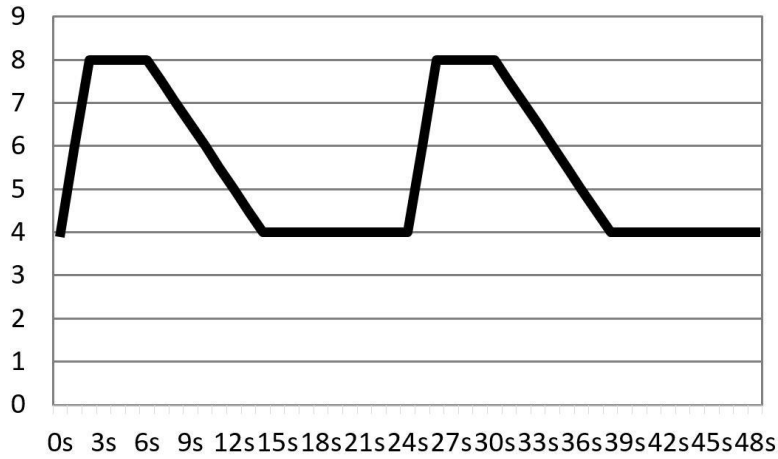

Deutsch

### Konfigurierbare Variablen

Durchflussbereich: 1-10		Zeitbereich: 2s-5m	
	Ebene 8		2s
	Ebene 4		8s
			4s
			20s

### Manuellen Modus

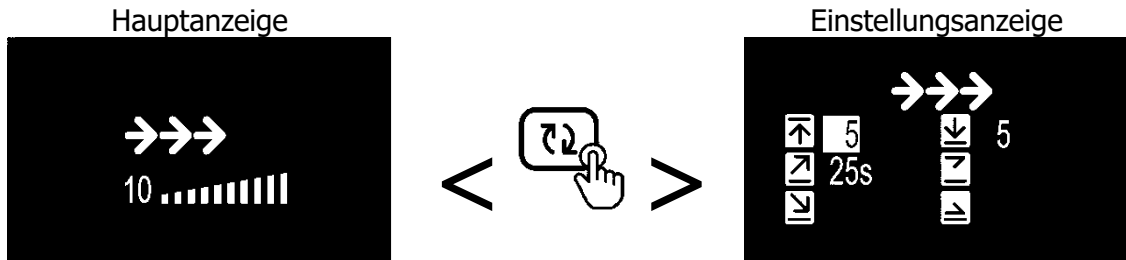

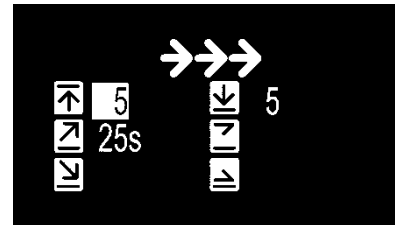

1. Um zwischen den Einstellungen zu wechseln auf drücken.
2. Den Drehknopf drehen um einen Wert einzustellen.
3. Auf die Taste drücken, um die Einstellung zu speichern.

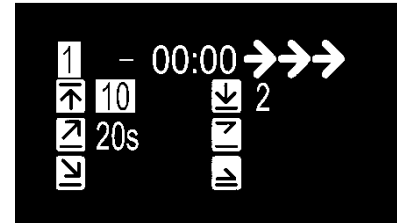
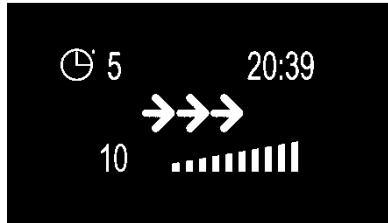

## Auto-Modus





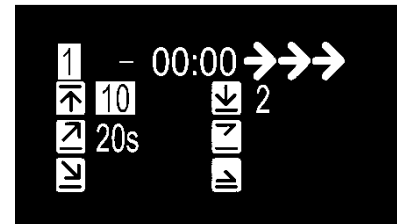

1. Um zwischen den Einstellungen zu wechseln auf  drücken.
2. Den Drehknopf drehen  um einen Wert einzustellen.
3. Auf die Taste  drücken, um die Einstellung zu speichern.



## Futter-Modus



Um den Futtermodus aufzurufen, in einer der Hauptanzeige auf  drücken.

1. Um die Einstellung zu speichern auf  drücken.
2. Um zwischen den Einstellungen zu wechseln auf  drücken.
3. Den Drehknopf drehen  um einen Wert einzustellen.
4. Auf die Taste  drücken, um die Einstellung zu speichern.

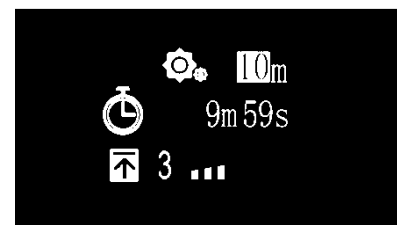

## Systemeinrichtung

Das Systemeinrichtungsmenu verfügt über eine Reihe von Funktionen, die es dem Benutzer ermöglichen, die Wartung des Gerätes durchzuführen.

Um das Systemeinrichtungsmenu aufzurufen, schalten Sie zuerst die Gerät aus und drücken Sie dann auf das Einstellrad, während Sie das Gerät wieder einschalten. Halten Sie das Einstellrad so lange gedrückt, bis das Systemeinrichtungsmenu auf dem OLED-Monitor angezeigt wird.

Deutsch

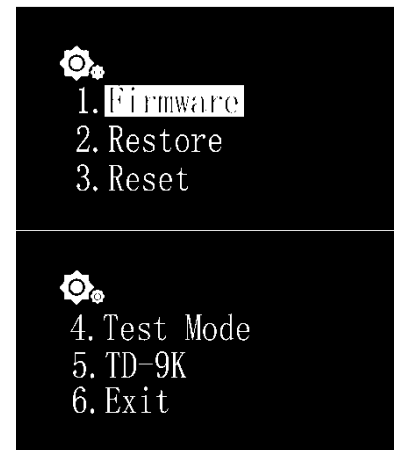

Es gibt 5 Funktionen im Systemeinrichtungsmenu.

1. Firmware
2. Wiederherstellen
3. Rücksetzen
4. Testmodus
5. Modellnummer
6. Verlassen



### 1. Firmware

Mit dieser Funktion kann der Benutzer die Firmware aktualisieren.

1. Drehen Sie das  um "Firmware" auszuwählen.
  2. Drücken Sie auf das , um die Firmware-Aktualisierung zu beginnen.
1. Wenn keine SD-Karte erkannt wird oder eine ungültige Firmware in der SD-Karte ist, wird "NO SD-Karte" oder "Wrong File" angezeigt.
  2. Andernfalls wird das Firmware-Update-Fortschritt angezeigt.

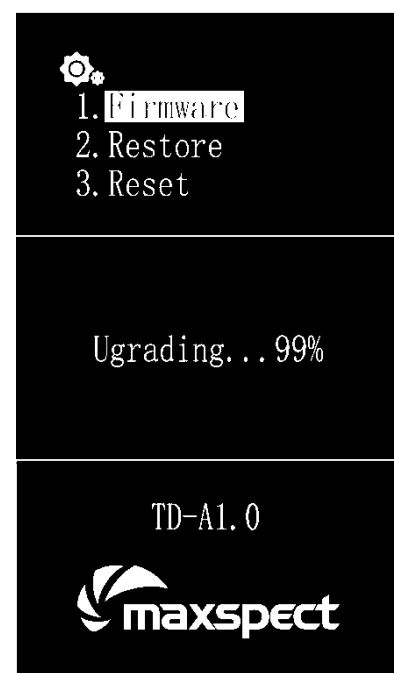

Sobald die Firmware-Aktualisierung erfolgreich war, wird das Gerät automatisch neu gestartet und die neue Firmware-Versionsnummer wird angezeigt.



## 2. Wiederherstellen

Mit dieser Funktion kann der Benutzer die Firmware auf die Werkseinstellung wieder zurückstellen. Nach Wiederherstellung der Firmware wird das Gerät automatisch neu gestartet und die Firmware-Versionsnummer wird angezeigt.



Deutsch

1. Drehen Sie das  um "Restore" auszuwählen.
2. Drücken Sie das  um die Firmware wiederherzustellen.



## 3. Rücksetzen

Diese Funktion ermöglicht es dem Benutzer, das Gerät wieder auf die Werkseinstellungen zurückzusetzen. Nach dem Zurücksetzen wird das Gerät automatisch neu gestartet.

1. Drehen Sie das  um "Reset" auszuwählen.
2. Drücken Sie auf das  um das Gerät auf die Werkseinstellungen zurückzusetzen.



## 4. Testmodus

Diese Funktion ermöglicht es dem Benutzer das Gerät in den Testmodus zu bringen um unserem Kundendienst zu helfen eine Diagnose von dem Gerät zu machen. **Dies sollte nur erfolgen, wenn ein autorisierter Fachhändler es von dem Benutzer verlangt, um einen bestimmten Test auf dem Gerät durchzuführen.**

## 5. Modellnummer

Diese Funktion zeigt die Modellnummer der Leuchte an und dient auch als ID-Name wenn die Turbine Duo über das Syna-G-System mit einem iOS- oder Android-Gerät verbunden wird. **Unter normalen Umständen sollte dieser Wert nicht geändert werden.**

## 6. Verlassen

1. Drehen Sie das  um "Exit" auszuwählen.
2. Drücken Sie auf das  um die Leuchte neu zu starten.

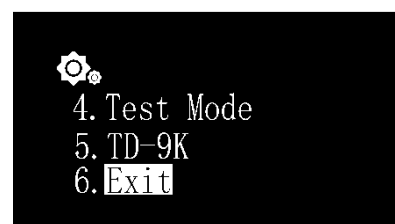

Maxspect Ltd. haftet für alle Produkte des Maxspect™ gegen Mängel in der Ausführung für einen Zeitraum von 12 Monaten ab dem Kaufdatum. Wenn ein Mangel während der Garantiezeit vorliegt, wird Maxspect Ltd das Produkt kostenlos nach eigenem Ermessen entweder reparieren (mit neu- oder Austauschteilen) oder das Produkt ersetzen (durch ein neues oder ein Austauschgerät).

DIE GARANTIE GILT NICHT FÜR PRODUKTE, DIE DURCH FALSCHER ANWENDUNG, VERÄNDERUNGEN, UNFÄLLE, UNSACHGEMÄSSE HANDHABUNG ODER EINGRIFFE BESCHÄDIGT WURDEN ODER AN DENEN REPARATUREN ODER REPARATURVERSUCHE VON NICHT-AUTORISIERTEN PERSONEN VORGENOMMEN WURDEN. ZU MÖGLICHEN SCHÄDEN, DIE NICHT VON DER GARANTIE ABGEDECKT SIND, GEHÖREN UNTER ANDEREM (ABER NICHT AUSSCHLIESSLICH) DER EINSATZ VON NACHGEMACHTEN LED-LEUCHTEN UND VERÄNDERUNGEN AN DEN SCHALTKREISEN, DIE VERMUTLICH SCHÄDEN AUFGRUND VON FALSCHER ANWENDUNG ODER MISSBRAUCH SIND.

**Deutsch****HAFTUNGSAUSSCHLUSS FÜR FOLGE- UND ZUFALLSSCHÄDEN:**

Sie und alle anderen Nutzer der Produkte von Maxspect Ltd. haben kein Recht auf Entschädigung bei Folge – und Zufallsschäden, einschließlich und ohne Einschränkung bei Verlust des Geräts, Unannehmlichkeiten, Schäden am Privateigentum, Telefonanrufe, entgangenes Einkommen und entgangene Umsätze. Diese Garantie gesteht Ihnen bestimmte Rechte zu und Sie können zudem weitere Rechte haben, die von Land zu Land unterschiedlich sein können.

MAXSPECT LTD. GIBT KEINE GARANTIE UND ÜBERNIMMT KEINE VERANTWORTUNG FÜR DAS PRODUKT, WEDER AUSDRÜCKLICH NOCH IMPLIZIT, IN BEZUG AUF DIE QUALITÄT, LEISTUNG, MARKTGÄNGIGKEIT ODER EIGNUNG FÜR EINEN BESTIMMTEN ZWECK. DAHER WIRD DAS PRODUKT IN DER VORLIEGENDEN FORM („AS IS“) VERKAUFT UND SIE ALS KÄUFER TRAGEN DAS GESAMTE RISIKO IN BEZUG AUF QUALITÄT UND LEISTUNG.

MAXSPECT LTD IST IN KEINEM FALL HAFTBAR FÜR DIREKTE, INDIREKTE, ZUFÄLLIGE SCHÄDEN BZW. FOLGESCHÄDEN, DIE AUS EINEM FEHLER DES PRODUKTS ODER SEINER BEDIENUNGSANLEITUNG ENTSTEHEN KÖNNTEN.

Die oben dargelegte Garantie, Haftungsausschlüsse und Rechtsbehelfe sind exklusiv und ersetzen alle anderen mündlichen oder schriftlichen, ausdrücklichen oder impliziten Absprachen. Zu keinem Zeitpunkt sind die Maxspect Ltd. Händler, Agenten oder Mitarbeiter berechtigt, irgendwelche Änderungen, Erweiterungen oder Zusätze an dieser Garantie vorzunehmen.

Einige Länder erlauben den Ausschluss oder die Beschränkung von implizierten Garantien oder Haftungen für Zufalls- oder Folgeschäden nicht, so dass die oben genannten Beschränkungen oder Ausschlüsse eventuell nicht auf Sie zutreffen.

### Hinweis:

Für die neuesten Spezifikationen der Turbine Duo DC Pumpe, besuchen Sie bitte:  
[www.maxspect.com](http://www.maxspect.com)



Deutsch



## ***Cher Client,***

Merci d'avoir acheté ce produit.

Pour des performances et une sécurité optimales, veuillez lire attentivement ces instructions.

### **Mémo utilisateur:**

Date d'achat :	_____
Nom du revendeur :	_____
Adresse du revendeur :	_____ _____
Site internet du revendeur :	_____
E-mail du revendeur :	_____
N° de téléphone du revendeur :	_____

Français

### **Vous pouvez nous rejoindre sur facebook ou twitter !**



<https://www.facebook.com/Maxspect>



<http://twitter.com/maxspectled>

## Contenu de l'emballage

**Merci de vérifier le contenu de votre emballage.**

### Composants principaux

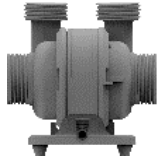

Pompe



Unité de Contrôle

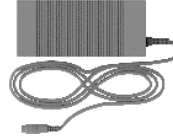

Alimentation



Câble d'alimentation



Adaptateur batterie de secours

Français

### Pièces pour entrée de pompe

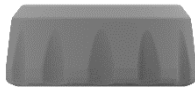

1. Φ58mm 2pcs



2. 1" 2pcs



2A. Φ32mm 2pcs



3. Φ40mm 2pcs



4. 2pcs



5. 2pcs

### Pièces pour double sortie de pompe

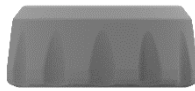

6. Φ51mm 2pcs

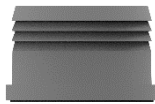

7. 3/4" 2pcs

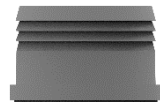

7A. Φ25mm 2pcs



7B. Φ16mm/1/2" 2pcs  
Φ20mm/ 3/4" 2pcs



7C. Φ25mm/1" 2pcs  
Φ32mm/1 1/4" 2pcs



8. Φ32mm 2pcs

## Contenu de l'emballage

### Pièces pour tube en Y

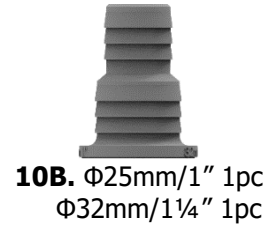
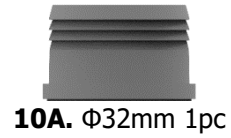
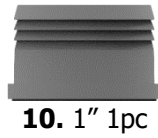
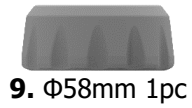

### Pièces pour unique sortie de pompe

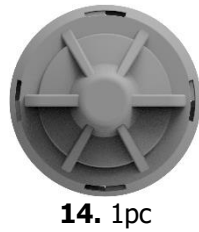

## Précautions d'utilisation

Avant toute utilisation du DC pompe Turbine Duo Maxspect™, veuillez lire attentivement ce manuel d'utilisation. Soyez particulièrement attentifs aux consignes de sécurité qui suivent.

Gardez soigneusement ce manuel pour toute future utilisation.

### LIRE ET SUIVRE TOUTES LES INSTRUCTIONS DE SÉCURITÉ

1. DANGER - Pour éviter tout risque d'électrocution, il faut prendre soin particulier car l'eau est utilisée dans l'utilisation d'un équipement d'aquarium. Pour chacune des situations suivantes, n'essayez pas de réparer vous-même; Renvoyer l'appareil à un service de service autorisé pour le service ou jeter l'appareil.

- Si l'appareil présente un signe de fuite d'eau anormale, débranchez-le immédiatement de la source d'alimentation.
- Examiner soigneusement l'appareil après l'installation. Il ne devrait pas être branché s'il y a de l'eau sur des pièces qui ne sont pas destinées à être humides.
- Ne faites pas fonctionner d'appareil s'il contient un cordon ou une fiche endommagée, ou s'il a un dysfonctionnement ou a été endommagé de quelque manière que ce soit.
- Pour éviter que la prise ou le réceptacle de l'appareil ne se mouille, placez le support d'aquarium et le réservoir d'un côté d'un réceptacle mural pour empêcher l'eau de couler sur le réceptacle ou la fiche. Une "bouée de goutte" illustrée sur la figure devrait être agencée par l'utilisateur pour chaque cordon reliant un appareil d'aquarium à un réceptacle. La «boucle d'égouttement» est la partie du cordon au-dessous du niveau de la prise, ou le connecteur si une rallonge est utilisée, pour éviter que l'eau ne se déplace le long du cordon et n'entre en contact avec la prise. Si la fiche ou la prise est humide, NE PAS débrancher le cordon. Débranchez le fusible ou le disjoncteur qui alimentent l'appareil. Ensuite, débranchez et examinez la présence d'eau dans le récipient.

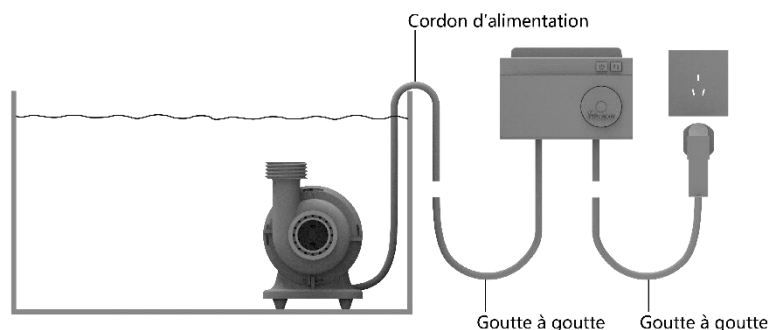

- Une surveillance étroite est nécessaire lorsque tout appareil est utilisé par ou près des enfants.
- Pour éviter les blessures, ne pas contacter les pièces mobiles ou les parties chaudes telles que les radiateurs, les réflecteurs, les ampoules et autres.

## Précautions d'utilisation

4. Toujours débrancher un appareil d'une prise lorsqu'il n'est pas utilisé, avant de mettre ou de retirer des pièces et avant de le nettoyer. Ne tirez jamais le cordon pour retirer la fiche de la prise. Saisissez la fiche et tirez pour la débrancher.
5. N'utilisez pas d'appareil pour une utilisation autre que prévue. L'utilisation de pièces jointes non recommandées ou vendues par le fabricant de l'appareil peut causer un état dangereux.
6. N'installez pas ou ne rangez pas les appareils où il sera exposé aux intempéries ou à des températures inférieures à la température de congélation.
7. Assurez-vous qu'un appareil monté sur un réservoir est bien installé avant de l'utiliser.
8. Lire et observer tous les avis importants sur l'appareil.
9. Si un cordon de rallonge est nécessaire, un cordon avec une bonne évaluation devrait être utilisé. Un cordon évalué pour moins d'ampères ou de watts que l'indice de l'appareil peut surchauffer.
10. Les cordons d'alimentation doivent être acheminés de sorte qu'ils ne risquent pas d'être piétinés ou pincés par des objets placés sur ou contre eux. Ne jamais saisir la fiche ou le cordon si votre main est humide et toujours saisir le corps de la fiche lors de la connexion ou la déconnexion.
11. La pompe est conçue pour être utilisée **UNIQUEMENT** dans l'eau. Aussi, celle-ci doit être **ENTIÈREMENT** immergée dans l'eau.

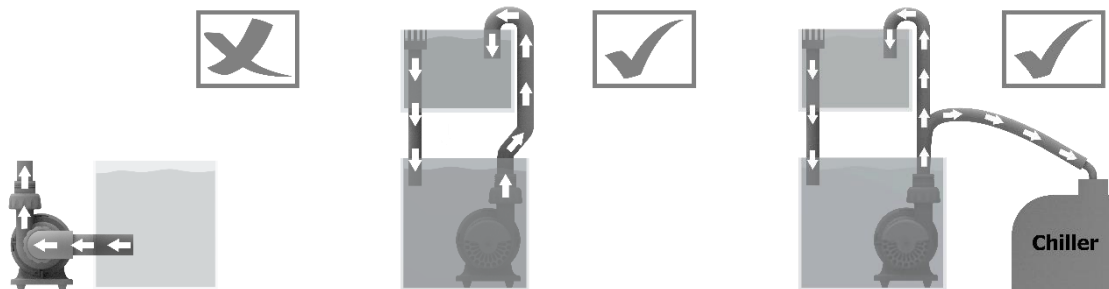

12. Pour obtenir les performances optimales, la distance verticale entre la sortie et l'entrée de la pompe ne doit pas être supérieure à 2 mètres.

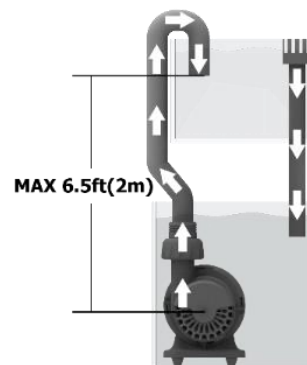

## Maintenance régulière de la pompe

### Entretien de la pompe

Votre pompe à courant continu, Turbine Duo, est conçue pour fonctionner de manière optimale avec peu d'attention après la configuration initiale. Cependant, en raison des conditions difficiles en aquariophilie d'eau de mer et en raison de l'accumulation d'algues et d'autres matières organiques, il est vivement conseillé de nettoyer la pompe pour assurer sa longévité. Aussi, Maxspect recommande de nettoyer la pompe au minimum tous les 6 mois ou plus souvent si nécessaire. Pour ce faire, il faut démonter la pompe, puis à l'aide d'une brosse douce, nettoyer délicatement la roue à aube ainsi que l'intérieur du corps de la pompe sous l'eau courante. En cas d'accumulation de calcium, il peut être nécessaire de tremper les pièces dans une solution d'eau et de vinaigre blanc. Ne pas utiliser d'acides puissants ou autres détergents car cela pourrait endommager les composants. Après nettoyage, remonter la pompe.

Français

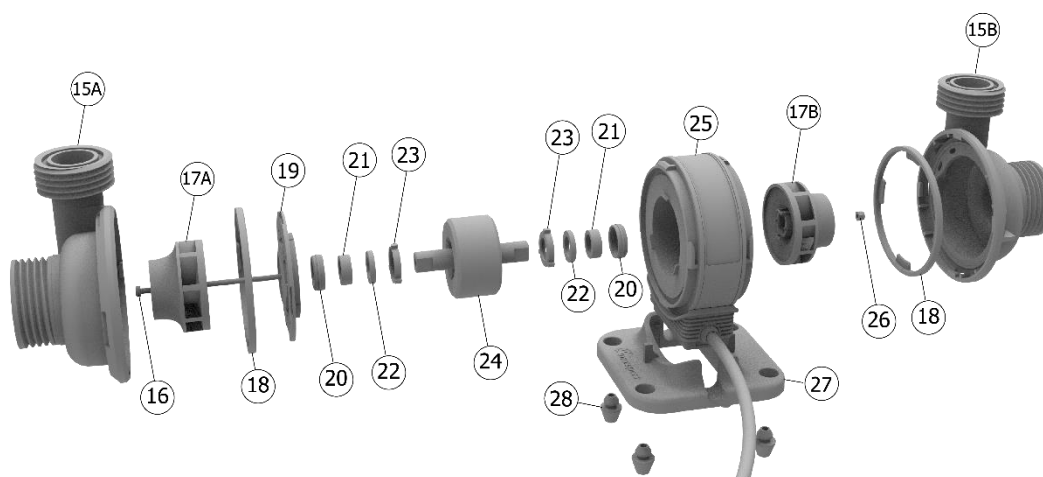

- |                                       |                                       |                         |                      |
|---------------------------------------|---------------------------------------|-------------------------|----------------------|
| 15A. Protection de la roue à aube (A) | 15B. Protection de la roue à aube (B) | 16. Vis                 | 17A. Roue à aube (A) |
| 17B. Roue à aube (B)                  | 18. Joint en silicone                 | 19. Couverture du rotor | 20. Pad en silicone  |
| 21. Roulement                         | 22. Roulement en céramique            | 23. Pad en silicone     | 24. Rotor            |
| 25. Stator                            | 26. Écrou                             | 27. Socle de la pompe   | 28. Pad en silicone  |

## Installation entrée de pompe

Pour une utilisation de la pompe Turbine Duo en circuit fermé, il est possible d'employer les raccords union 2 ou 2A, en fonction de la taille du tuyau ou du tube à adapter.

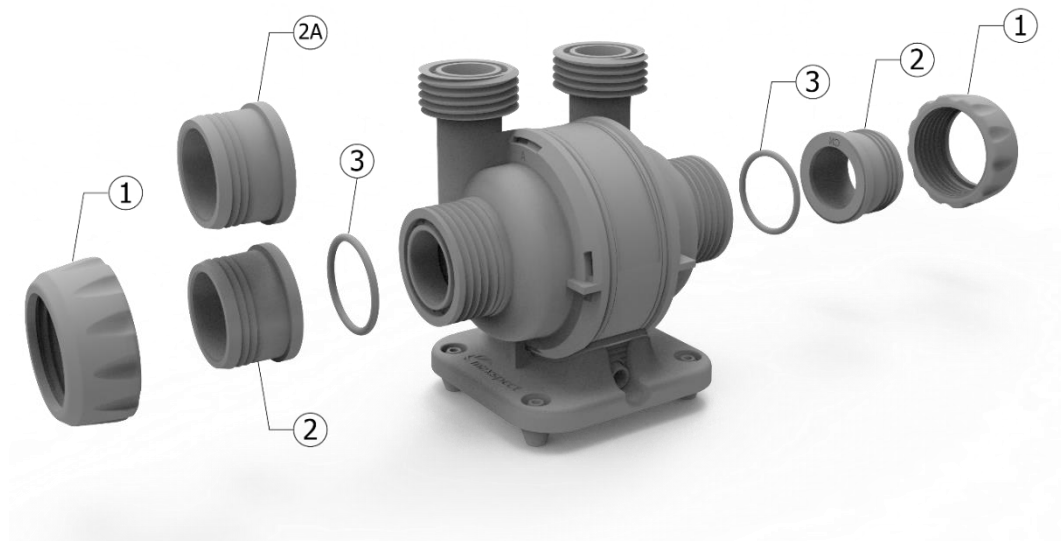

Français

Pour une utilisation de la pompe Turbine Duo comme pompe de retour, il est possible d'installer 2 grilles de protection 4 sur l'admission.

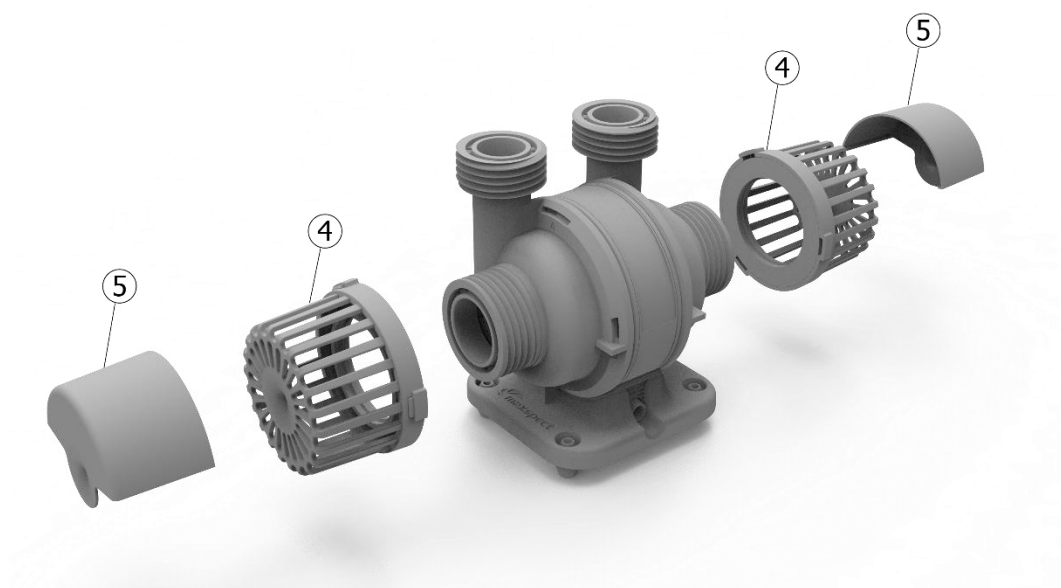

## Installation sortie de pompe

**En double sortie :** En fonction du tube PVC ou du tuyau à adapter, différents raccords sont disponibles : 7 / 7A / 7B / 7C.

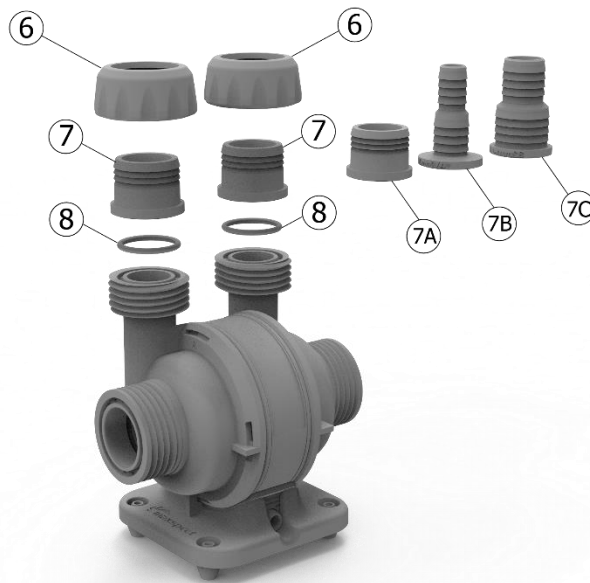

**En sortie combinée avec tube en Y :** En fonction du tube PVC ou du tuyau à adapter, différents raccords sont disponibles : 10 / 10A / 10B.

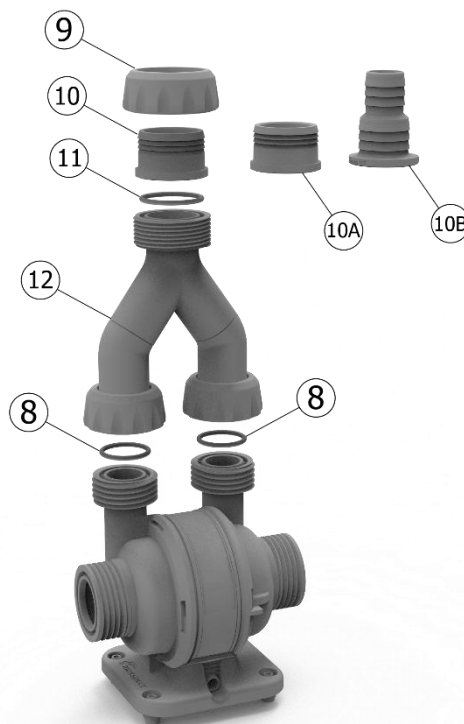



## Installation

**En sortie simple :** pour une utilisation de la pompe en simple sortie, la protection de la roue à aube B peut être remplacé par la protection 14.

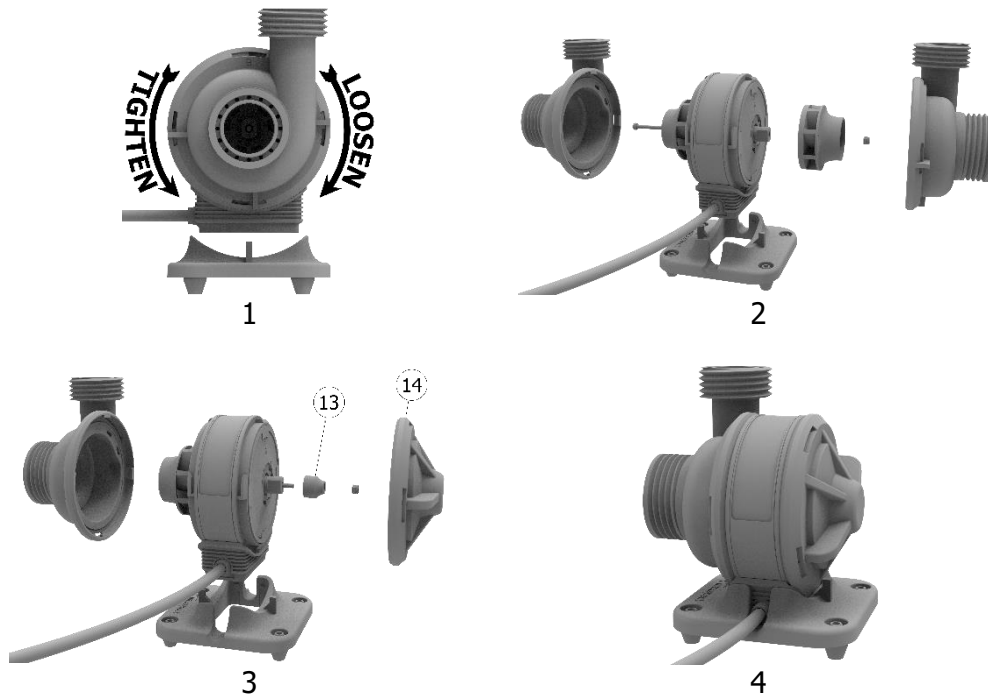

**Important :** seul la protection de la roue à aube B peut être remplacé la protection 14. Le socle de la pompe doit être installée avant la mise en service.

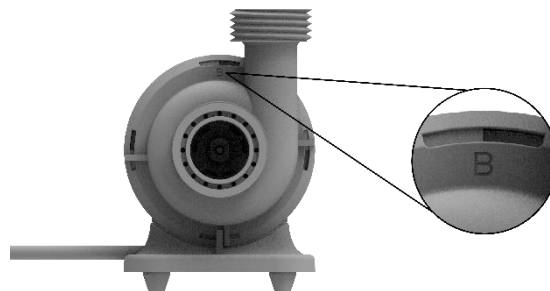

### Direction des sorties

Les protections des roues à aube A et B peuvent être installés dans trois directions.



Français

## Instructions d'utilisation

### L'unité de commande de la Turbine Duo

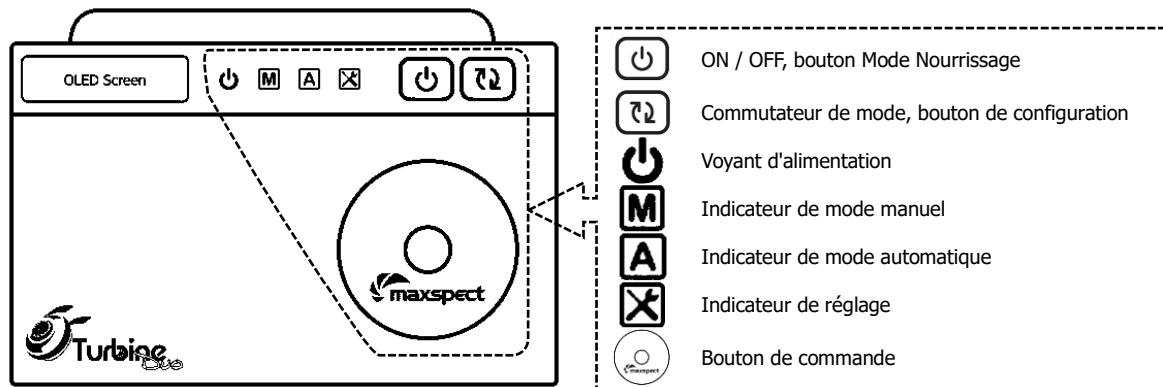

Français

### Allumer / éteindre la Turbine Duo

Appuyer et maintenir la touche ON / OFF plus de 4s pour allumer ou éteindre la pompe. Quand éteint est activé, la pompe cesse de fonctionner, les indicateurs et l'écran OLED du contrôleur s'éteignent aussi. Toutefois, si la pompe est connectée à un ICV6 (vendu séparément) celle-ci pourra toujours être contrôlée via l'application Syna-G.

### Initialisation de la Turbine Duo

Avant utilisation de la pompe Turbine Duo, certains réglages sont à effectuer.

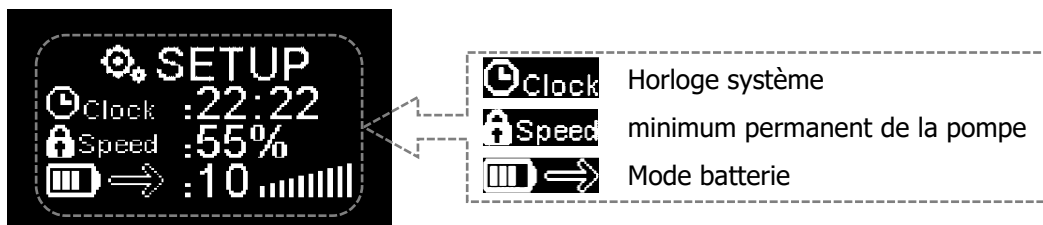





**Horloge:** configurez l'horloge système pour qu'elle corresponde à votre heure locale.

**Speed:** configuration du débit minimum permanent de la pompe. Ce paramètre sera appliqué en toutes circonstances. Le débit minimum peut être réglée de 1% à 90%.

**Mode batterie :** configuration du débit de la pompe lorsqu'elle est alimentée par une batterie de secours. La pompe est livrée avec un adaptateur de commutation d'alimentation, pourvu de 2 câbles qui sont prévus pour 2 sources d'alimentation différentes. Un câble se connecte à l'unité d'alimentation livrée avec la pompe tandis que l'autre câble peut être connecté à une batterie DC12v (vendue séparément). Lorsqu'il n'y a plus de courant sur l'unité d'alimentation, la pompe sera automatiquement alimentée par la batterie.



## Instructions d'utilisation

- Lorsque l'écran OLED est allumé, pour accéder à la page de configuration, il faut appuyer simultanément sur les 2  et .
- Appuyez sur  pour changer les différents paramètres.
- Tourner  pour définir une valeur.
- Appuyez sur  pour sauvegarder les paramètres.



### Changement entre le mode automatique et manuel

**Mode manuel :** configuration manuelle du mode de circulation d'eau et de la puissance du débit de la pompe Turbine Duo.

**Mode Auto :** Ensemble de programmes avec mode de circulation d'eau et puissance du débit programmables, pour un cycle de 24 heures.

Français

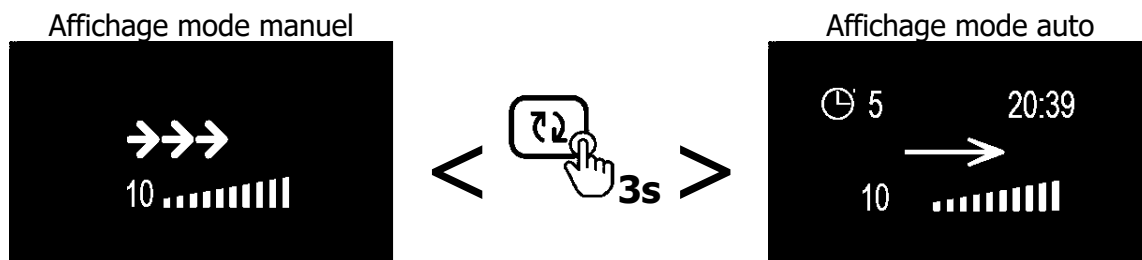

### Présentation de l'affichage

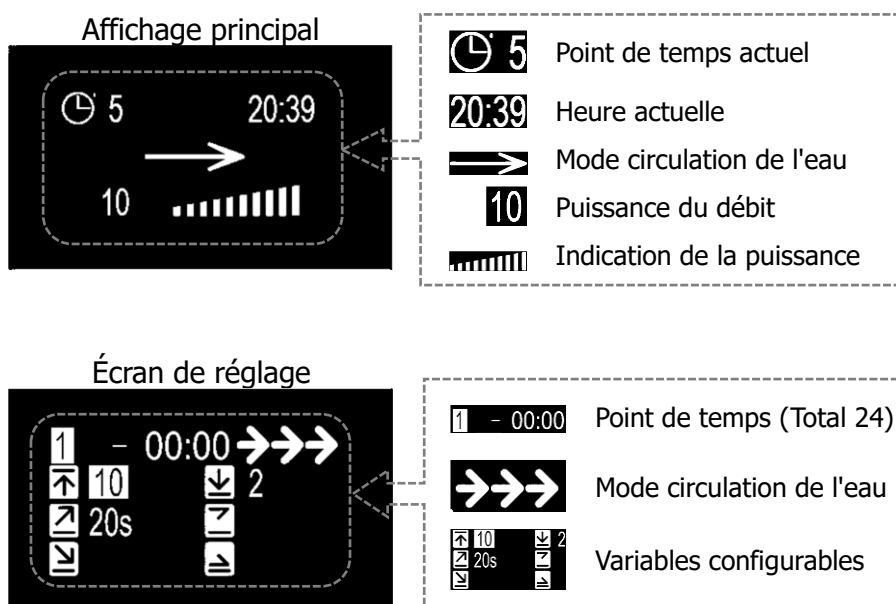

# Instructions d'utilisation

## Icône de l'écran OLED

### Modes circulation de l'eau



Mode flux constant



Mode flux pulsé



Mode aléatoire



Mode flux avancé

### Variables



Débit maximal



Temps de montée



Temps de débit maximum



Débit minimum



Temps de descente



Temps de débit minimum

### Variables illustrées

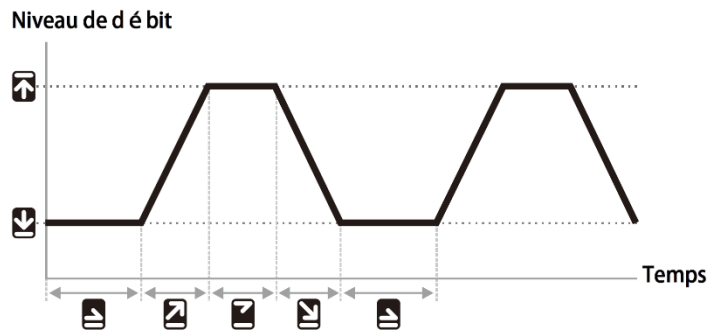

### Illustration du mouvement de l'eau



Mode flux constant

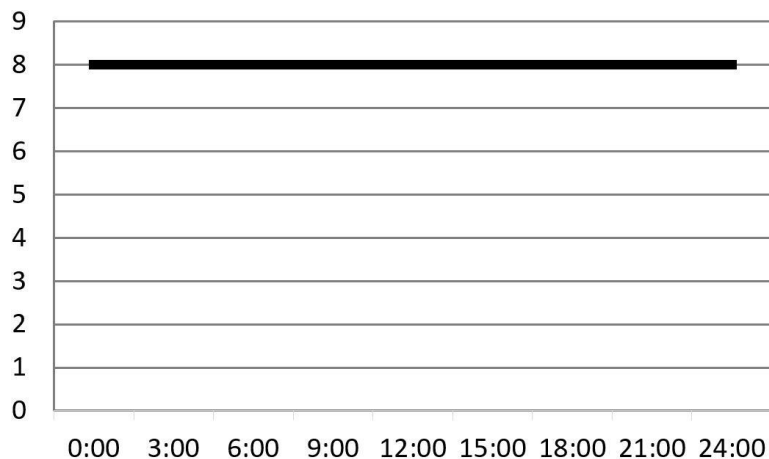

### Variables configurables

Plage de débit: 1-10



Niveau 8



N/A



N/A



N/A



N/A



N/A

# Instructions d'utilisation



## Mode flux pulsé

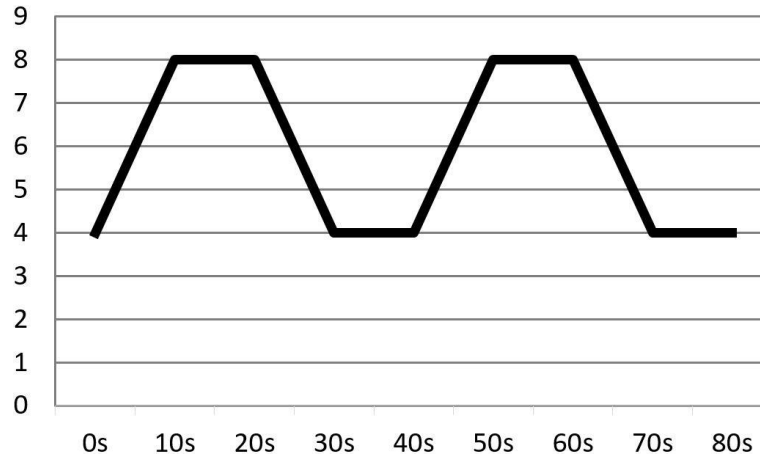

Français

### Variables configurables

Plage de débit: 1-10    Plage de temps: 2-30s

	Niveau 8		10s		N/A
	Niveau 4		N/A		N/A
	=		=		=
= 10s					



## Mode aléatoire

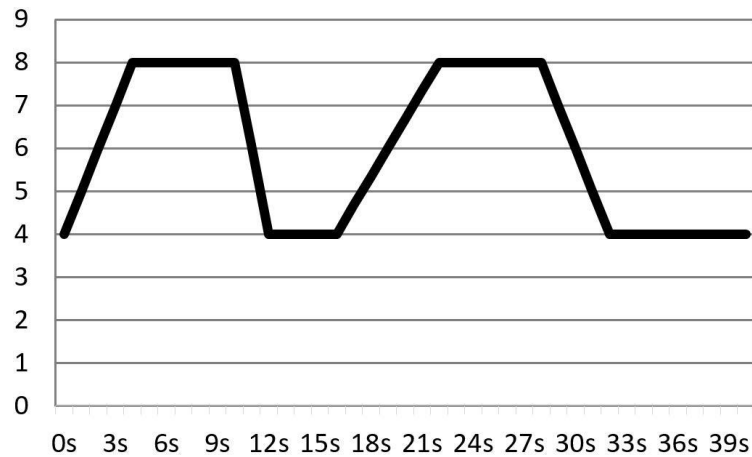

### Variables configurables

Plage de débit maximale: 2-10    Mini débit: 1-9

	Niveau 8		N/A		N/A
	Niveau 4		N/A		N/A

# Instructions d'utilisation

## Mode flux avancé



Français

### Variables configurables

- Plage de débit: 1-10    Plage de temps: 2s-5m
- |   |          |   |    |   |     |
|---|----------|---|----|---|-----|
|  | Niveau 8 |  | 2s |  | 4s  |
|  | Niveau 4 |  | 8s |  | 20s |

### mode manuel

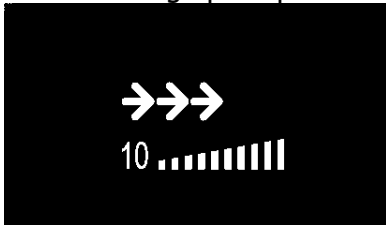

Affichage principal

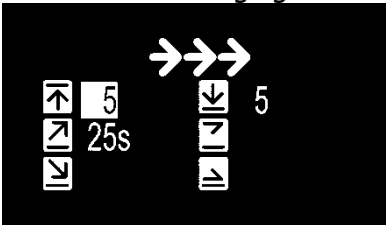

<  >

Écran de réglage





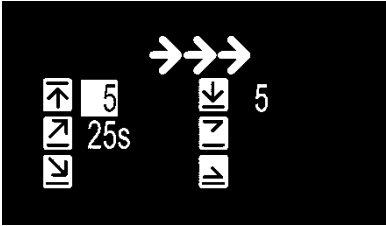

1. Appuyez sur  pour changer les différents paramètres.
2. Tourner  pour définir une valeur.
3. Appuyez sur  pour sauvegarder les paramètres.

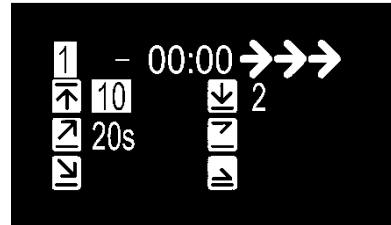
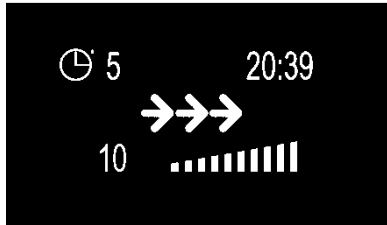

# Instructions d'utilisation

## Mode Auto



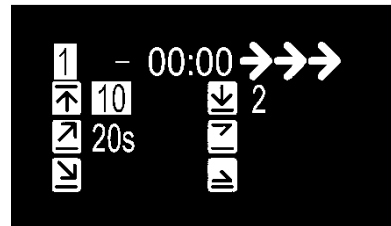

1. Appuyez sur  pour changer les différents paramètres.
2. Tourner  pour définir une valeur.
3. Appuyez sur  pour sauvegarder les paramètres.



Français





## Mode Nutrition

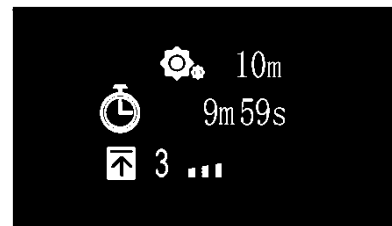

	10m	Temps d'alimentation (Max 60m)
	9m 59s	Compte à rebours
	3	Niveau de débit

Pour accéder au mode nourrissage, appuyer sur  dans l'un des écrans principaux.



1. Pour sauvegarder les réglages, appuyer sur .
2. Appuyez sur  pour changer les différents paramètres.
3. Tourner  pour définir une valeur.
4. Appuyez sur  pour sauvegarder les paramètres.

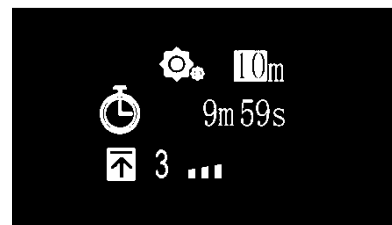

## Instructions de maintenance

### Configuration du système

La configuration du système comporte un ensemble de fonctions permettant à l'utilisateur de réaliser une maintenance sur la pompe.

Pour accéder au menu de configuration du système, éteindre d'abord l'appareil, puis appuyer et maintenir la molette de commande tout en allumant l'appareil. Maintenir la molette de commande jusqu'à ce que le menu de configuration du système soit affiché sur le moniteur OLED.

5 fonctions s'affichent sur l'écran de configuration du système.

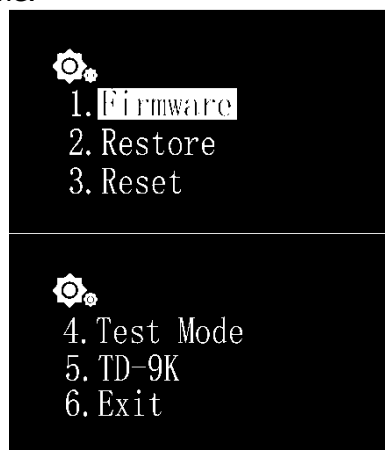

Français

1. Firmware
2. Restaurer
3. Réinitialiser
4. Mode Test
5. Numéro du modèle
6. Quitter



#### 1. Firmware

Cette fonction permet à l'utilisateur de mettre à jour le firmware.

1. Tourner  pour sélectionner "Firmware".
2. Appuyez sur  pour faire la mise à jour du firmware.

1. S'il n'y a pas de carte SD ou si le firmware sur la carte SD est incorrect, „NO SD-Karte“ ou „Wrong File“ seront affichés.
2. Dans le cas contraire, la progression de la mise à jour du firmware sera affichée.

Une fois le firmware mis à jour, la rampe redémarre automatiquement et la nouvelle version du firmware sera affichée.

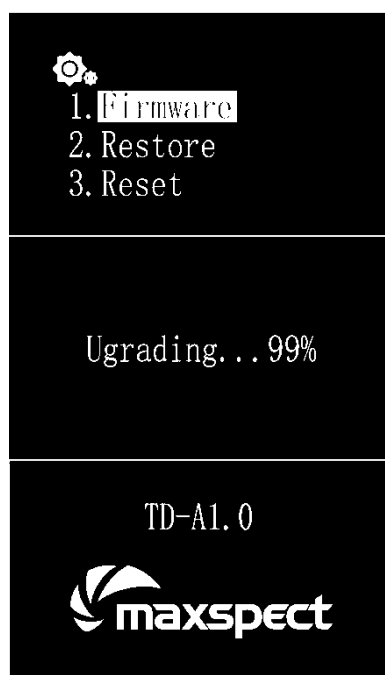



## Instructions de maintenance

### 2. Restaurer

Cette fonction permet à l'utilisateur de restaurer le firmware au réglage d'usine. Après avoir terminé la restauration du firmware, la rampe redémarre automatiquement et la version du firmware sera affichée.

1. Tourner  pour sélectionner "Restore".
2. Appuyez sur  pour restaurer le firmware.



### 3. Réinitialiser

Cette fonction permet à l'utilisateur de réinitialiser la rampe en réglage d'usine. Après réinitialisation, la rampe redémarre automatiquement.

1. Tourner  pour sélectionner "Reset".
2. Appuyer sur  pour réinitialiser la pompe.



### 4. Mode Test

Cette fonction permet à l'utilisateur de mettre la rampe en mode test afin d'aider notre service après-vente à faire un diagnostic de celle-ci. **Cette fonction ne doit être utilisée que lorsqu'un revendeur agréé le demande pour effectuer certains tests sur la rampe.**

### 5. Numéro du modèle

Cette fonction affiche le numéro de modèle de l'appareil, qui sert également de nom ID lorsque la Turbine Duo est connectée à un périphérique iOS ou Android via le système Syna-G. **Normalement cette valeur ne doit pas être modifiée.**

### 6. Exit

1. Tourner  pour sélectionner "Exit".
2. Appuyer sur  pour redémarrer la pompe.

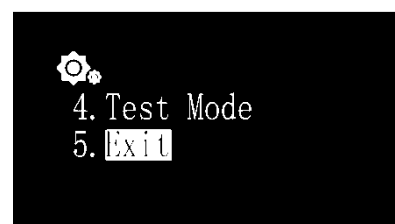

## Limite de garantie

Maxspect Ltd. garantit tous les produits Maxspect™ contre les défauts de fabrication ou de matériaux pendant une période de 12 mois à compter de la date d'achat. Si un défaut est révélé au cours de la période de garantie, Maxspect Ltd., à sa convenance, réparera (avec des pièces neuves ou de rechanges) ou remplacera (par une unité nouvelle ou réparée) le produit, gratuitement.

LA GARANTIE NE S'APPLIQUE PAS AU PRODUIT S'IL A ÉTÉ ENDOMMAGÉ PAR UNE MAUVAISE UTILISATION SUITE À UNE MAUVAISE MANIPULATION, UNE INSTALLATION INCORRECTE, AU TRANSPORT OU POUR DES TENTATIVES DE RÉPARATION PAR DES PERSONNES NON AUTORISÉES. DES EXEMPLES DE DOMMAGES NON COUVERTS PAR LA GARANTIE INCLUENT, MAIS NE SE LIMITENT PAS A L'UTILISATION DE LED DE REMPLACEMENT ET MODIFICATION DES CIRCUITS DONT POURRAIENT RESULTER DES DOMMAGES DUS A UNE MAUVAISE UTILISATION OU UN MAUVAIS TRAITEMENT.

### **EXCLUSION DE DOMMAGES IMMATERIELS OU ACCESSOIRES :**

Maxspect Ltd. ne peut en aucun cas être tenu pour responsable des dommages directs, indirects ou conséquents comprenant mais non limités à : la perte de l'usage de l'unité, désagréments, dégâts matériels à des biens personnels, appels téléphoniques, perte de revenus ou de salaire. Cette garantie vous donne des droits légaux spécifiques ainsi que d'autres droits éventuels, qui peuvent varier d'un pays à l'autre.

MAXSPECT LTD. N'OFFRE AUCUNE GARANTIE, QU'ELLE SOIT EXPRESSE OU IMPLICITE, QUANT A LA QUALITE DES PRODUITS, LES PERFORMANCES, SA COMMERCIALISATION OU L'ADAPTATION A UN USAGE DIFFERENT DE CELUI AUQUEL IL EST DESTINE. EN CONSEQUENCE, CES PRODUIT SONT VENDUS «TELS QUELS», ET VOUS, ACHETEUR, ASSUMEZ ENTIEREMENT LES RISQUES QUANT A SA QUALITE ET SES PERFORMANCES.

EN AUCUN CAS MAXSPECT LTD NE SERA RESPONSABLE DE DOMMAGES DIRECTS, INDIRECTS, PARTICULIERS, ACCESSOIRES OU CONSECUTIFS RESULTANTS DE TOUT DEFAUT DU PRODUIT OU DE SA DOCUMENTATION.

LA GARANTIE, L'EXCLUSION ET LES MESURES PREVUES PRECEDEMMENT SONT EXCLUSIVES, ET REMPLACENT TOUTES LES AUTRES, ORALES OU ECRITES, EXPLICITES OU IMPLICITES. En aucun cas, des revendeurs, agents ou employés de Maxspect Ltd. ne seront autorisés à apporter des modifications, extensions ou ajouts à cette garantie.

Certains pays ne permettent pas l'exclusion ou la limitation des garanties implicites ou la responsabilité pour les dommages directs ou indirects, de sorte que la limitation ou l'exclusion de cette garantie peut ne pas vous être appliqué.

## Caractéristiques

### Remarque :

Pour les dernières spécifications de Turbine Duo DC Pump, visitez: [www.maxspect.com](http://www.maxspect.com)



Français

## ***Gentile Cliente,***

Grazie e complimenti per aver acquistato il nostro prodotto .

Per ottimizzare prestazioni e sicurezza, vi preghiamo di leggere attentamente le istruzioni

### **Utente memo:**

Data di acquisto: \_\_\_\_\_

Rivenditore: \_\_\_\_\_

Indirizzo del rivenditore: \_\_\_\_\_

Sito web del rivenditore: \_\_\_\_\_

E-mail del rivenditore: \_\_\_\_\_

Telefono del rivenditore: \_\_\_\_\_

Italiano

### **Puoi seguirci su facebook e twitter!**



<https://www.facebook.com/Maxspect>



<http://twitter.com/maxspectled>

## Contenuto Scatola

**Per favore verifica il contenuto della scatola.**

### Componenti principali

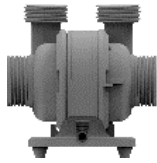

Pompa



Controllore

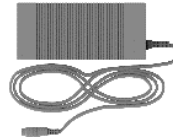

Alimentatore



Cavo di alimentazione



Adattatore batteria di backup

### Ricambi aspirazione

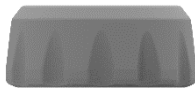

1.  $\Phi 58\text{mm}$  2pcs

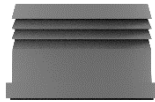

2. 1" 2pcs

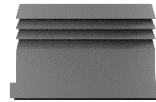

2A.  $\Phi 32\text{mm}$  2pcs



3.  $\Phi 40\text{mm}$  2pcs



4. 2pcs



5. 2pcs

### Ricambi uscita Duo

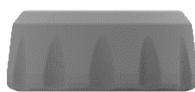

6.  $\Phi 51\text{mm}$  2pcs

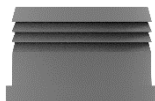

7.  $\frac{3}{4}"$  2pcs

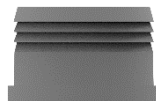

7A.  $\Phi 25\text{mm}$  2pcs



7B.  $\Phi 16\text{mm}/\frac{1}{2}"$  2pcs  
 $\Phi 20\text{mm}/\frac{3}{4}"$  2pcs



7C.  $\Phi 25\text{mm}/1"$  2pcs  
 $\Phi 32\text{mm}/1\frac{1}{4}"$  2pcs



8.  $\Phi 32\text{mm}$  2pcs

Italiano

## Contenuto Scatola

### Ricambi tutatura a Y



**9.**  $\Phi 58\text{mm}$  1pc

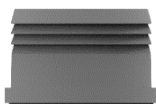

**10.** 1" 1pc



**10A.**  $\Phi 32\text{mm}$  1pc



**10B.**  $\Phi 25\text{mm}/1''$  1pc  
 $\Phi 32\text{mm}/1\frac{1}{4}''$  1pc



**11.**  $\Phi 40\text{mm}$  1pc



**12.** 1pc

### Ricambi uscita singola



**13.** 1pc



**14.** 1pc

## Precauzioni

Prima di utilizzare il a DC Pump Maxspect™ Turbine Duo hiamo di leggere attentamente le istruzioni. Far particolare attenzione e seguire i suggerimenti di sicurezza elencati di seguito.  
Successivamente tenere questo manuale a portata di mano per riferimento futuri

### LEGGERE E SEGUIRE TUTTE LE ISTRUZIONI DI SICUREZZA

1. PERICOLO - Per evitare possibili scosse elettriche, occorre prestare particolare attenzione in quanto l'acqua viene utilizzata nell'uso dell'acquario. Per ciascuna delle seguenti situazioni, non tentare di riparare da soli; Rimettere l'apparecchio ad un servizio di assistenza autorizzato per il servizio o scartare l'apparecchio.
  - a) Se l'apparecchio presenta segni di perdite d'acqua anomale, scollegarlo immediatamente dalla fonte di alimentazione.
  - b) Esaminare attentamente l'apparecchio dopo l'installazione. Non deve essere collegato se c'è acqua su parti non destinate ad essere bagnate.
  - c) Non utilizzare alcuna apparecchiatura se presenta un cavo o una spina danneggiati o se è malfunzionante o è stata scaricata o danneggiata in qualsiasi modo.
  - d) Per evitare che la spina o il recipiente dell'apparecchio venga bagnato, posizionare il basamento dell'acquario e il serbatoio su un lato di una presa a parete per evitare che l'acqua sgocciolasse sul recipiente o sulla spina. Un "anello di gocciolamento" indicato in figura deve essere disposto dall'utente per ciascun cavo che collega un'apparecchiatura ad acquario ad un recipiente. Il "gocciolatoio" è quella parte del cavo sotto il livello del contenitore o il connettore se viene utilizzato un cavo di prolunga, per evitare che l'acqua attraversa il cavo e venga a contatto con il recipiente. Se la spina o la presa si bagnano, non scollegare il cavo. Scollegare il fusibile o l'interruttore che alimenta l'apparecchio. Scollegare ed esaminare la presenza di acqua nel recipiente.

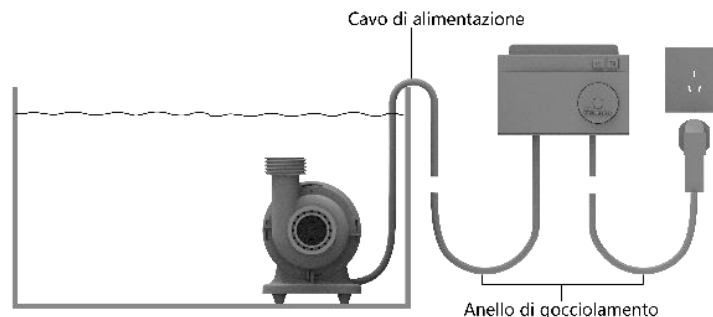

2. È necessaria una stretta supervisione quando un apparecchio viene utilizzato da o vicino ai bambini
3. Per evitare infortuni, non rivolgersi a parti in movimento o parti calde come riscaldatori, riflettori, lampadine e simili.

## Precauzioni

4. Scollegare sempre l'apparecchio da una presa quando non è in uso, prima di mettere o togliere parti e prima di pulire. Non attaccare mai il cavo per tirare la spina dalla presa. Afferrare la spina e tirare per scollegare.
5. Non utilizzare un apparecchio diverso da quello previsto. L'uso di accessori non raccomandati o venduti dal produttore dell'apparecchio può causare una condizione di pericolo
6. Non installare o conservare le apparecchiature in cui sarà esposto al tempo o a temperature sotto il congelamento.
7. Assicurarsi che un apparecchio montato su un serbatoio sia installato correttamente prima di utilizzarlo.
8. Leggere e osservare tutte le notizie importanti sull'apparecchio.
9. Se è necessario un cavo di prolunga, utilizzare un cavo con un valore adeguato. Un cavo valutato per meno di amper o watt che il valore dell'apparecchio potrebbe surriscaldarsi.
10. I cavi di alimentazione dovrebbero essere indirizzati in modo che non siano probabili essere percorsi o pizzicati da oggetti posizionati su o contro di loro. Non tenere mai la spina o il cavo se la vostra mano è bagnata e afferrare sempre il corpo della spina quando si collega o scollegare.
11. L'apparecchio è progettato per essere utilizzato SOLO nell'acqua, l'intero corpo dell'apparecchio deve essere immerso nell'acqua.

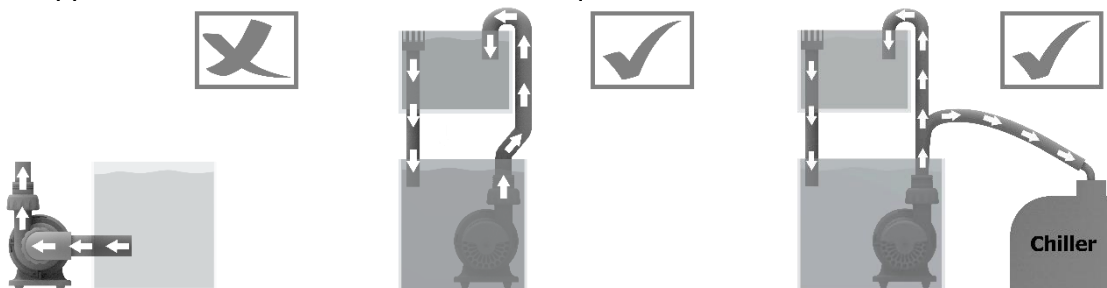

12. Per mantenere le buone prestazioni dell'apparecchio, esso deve essere installato dove la distanza verticale tra l'uscita e l'ingresso è inferiore a 6,5 piedi (2 m).

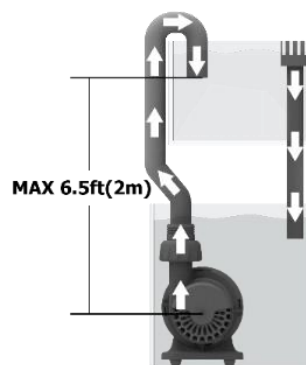



## Manutenzione ordinaria della pompa

### Manutenzione dell'apparecchio

La pompa a Turbine Duo DC è stata progettata per funzionare in modo ottimale con poca attenzione dopo l'installazione iniziale. Tuttavia, a causa delle dure condizioni di un acquario di acqua salata e del conseguente accumulo di alghe e di altre sostanze organiche è consigliabile pulire la pompa per garantire la longevità dell'apparecchio. Maxspect raccomanda di effettuare una pulizia ogni 6 mesi o a seconda delle necessità. Ciò può essere effettuato aprendo il vano della girante e spazzolando delicatamente la girante ed il vano stesso con una spazzola morbida sotto acqua corrente. Se c'è un accumulo di calcio, potrebbe essere necessario mettere queste parti ammollo in una soluzione lievemente acida come l'aceto. Non utilizzare acidi forti perché potrebbero danneggiare i componenti. Dopo la pulizia riassemblare l'apparecchio.

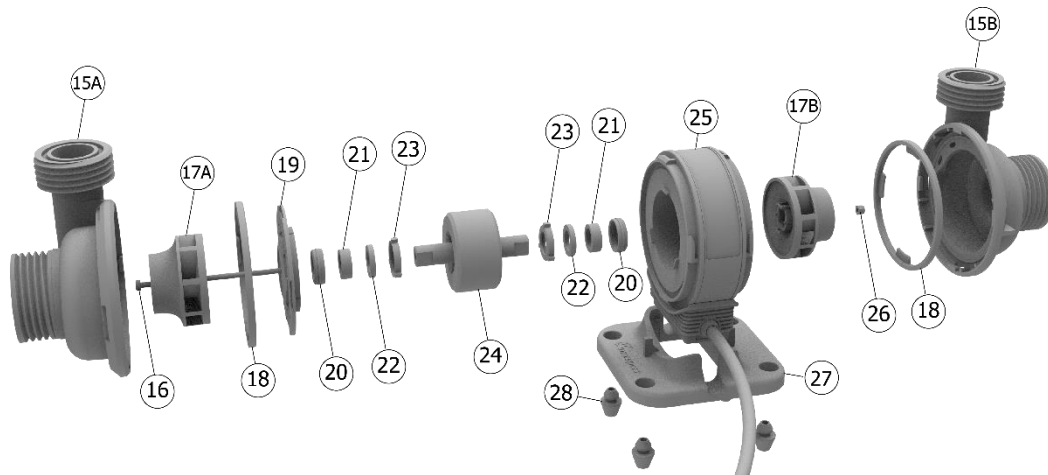

- |                                 |                                 |                            |                            |
|---------------------------------|---------------------------------|----------------------------|----------------------------|
| 15A. Alloggio della girante (A) | 15B. Alloggio della girante (B) | 16. Vite                   | 17A. Girante (A)           |
| 17B. Girante (B)                | 18. Guarnizione in silicone     | 19. Copri rotore           | 20. Cuscinetto in silicone |
| 21. Rondella                    | 22. Rondella in ceramica        | 23. Cuscinetto in silicone | 24. Rotore                 |
| 25. Statore                     | 26. Dado                        | 27. Base della pompa       | 28. Cuscinetto in silicone |

Italiano

## Installazione dell'ingresso

È possibile scambiare i raccordi 2 / 2A tra di loro per adattarlo a un tubo di dimensioni diverse in quanto la Turbine Duo funziona come una pompa a circuito chiuso.

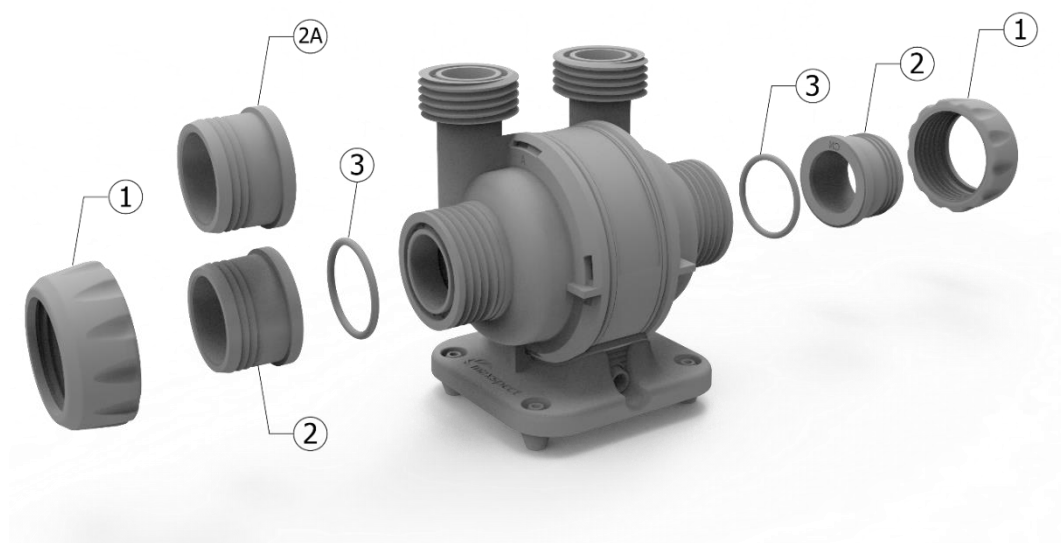

Oppure è possibile installare due griglie di aspirazione per farla funzionare come pompa di ritorno.

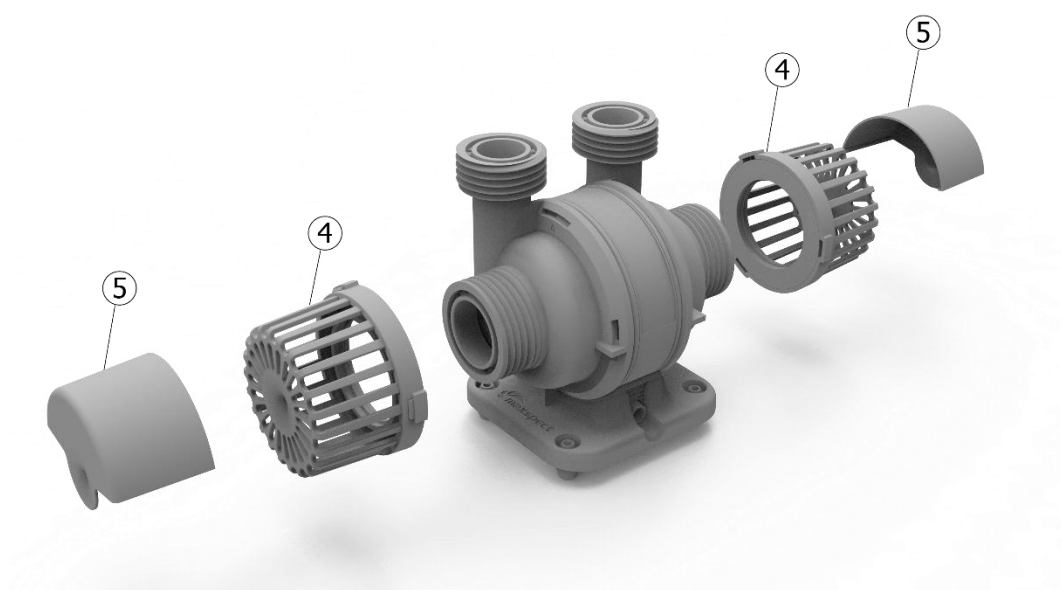

## Installazione dell'uscita

**Uscite della Duo:** Scambia i raccordi tra 7 / 7A / 7B / 7C per adattare ai tubi di varie dimensioni.

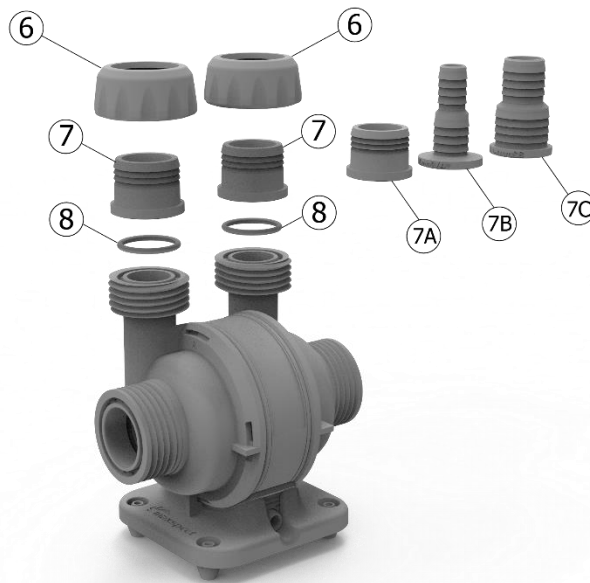

Italiano

**L'uscita combinata con l'utilizzo del raccordo a Y:** scambia i raccordi tra 10/10A/10B a seconda del diametro del tubo.

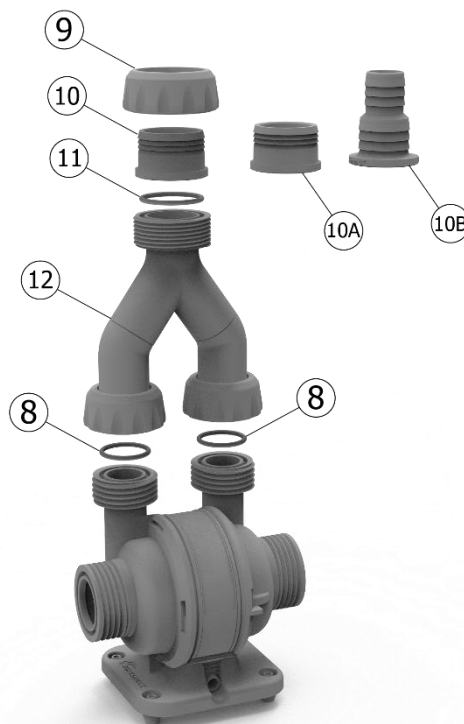

**Luscita singola:** puoi anche sostituire l'alloggio del rotore B con il tappo per farla funzionare come pompa DC a singola uscita.

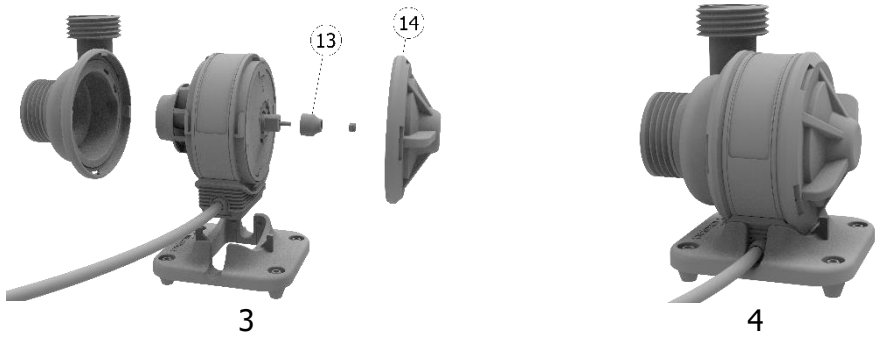

**Importante:** solo il vano del rotore B può essere sostituito con il tappo.

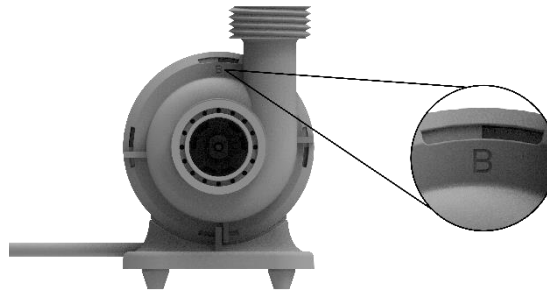

## Direzione dell'uscita

Sia il vano del rotore A sia quello del rotore B possono essere installati in 3 direzioni.



## Istruzioni Per L'Uso

### Unità di controllo dalla Turbine Duo

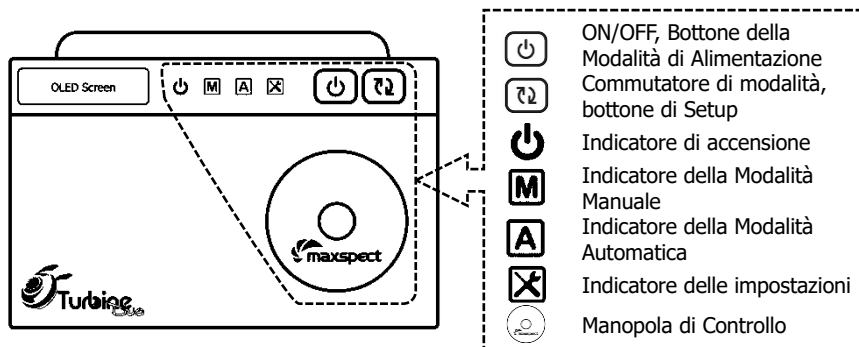

### Interruttore ON/OFF della Turbine Duo

Premere e tenere premuto il pulsante ON / OFF per 4s per accendere o spegnere l'apparecchio. Mentre l'apparecchio viene spento, la pompa si arresta, gli indicatori e lo schermo OLED del controllore si spengono. Tuttavia, se l'apparecchio è collegato ad un ICV6 (venduto a parte), può ancora restare attivato dall'applicazione Syna-G.

Italiano

### Inizializza la Tua Turbine Duo

Prima di utilizzare l'apparecchio, è necessario impostare alcune impostazioni di base per il vostro Turbine Duo.

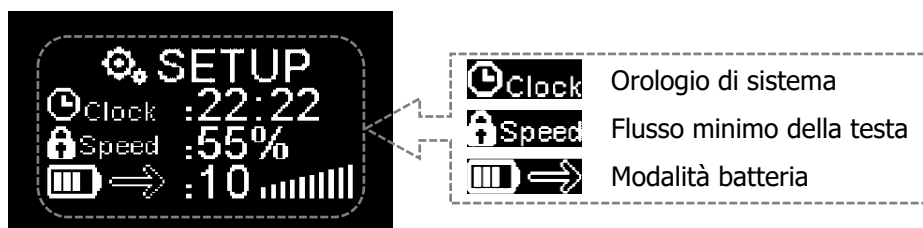





**Orologio:** Imposta l'orologio del sistema per adattarsi all'ora locale.

**Velocità:** Impostare il flusso minimo della pompa per tutti i tempi. Significa che l'impostazione del flusso d'acqua minimo per tutte le modalità di movimento dell'acqua sarà calcolata in base a questo valore. Il range di portata regolabile minima della pompa è compreso tra 1% e 90%.

**Modalità batteria:** Impostare la velocità di funzionamento della pompa mentre è alimentata da una batteria di riserva. Il prodotto è dotato di un adattatore per interruttori di alimentazione dotato di due cavi di alimentazione, una estremità collegata all'unità di alimentazione offerta da Maxspect, l'altra estremità si collega a una batteria DC12v (venduta separatamente). Quando la potenza dell'alimentatore viene interrotta, la sorgente di alimentazione verrà automaticamente commutata alla batteria.



## Istruzioni Per L'Uso

1. Mentre è attiva la schermata OLED, premere contemporaneamente entrambi i pulsanti  e  per accedere alla pagina di configurazione.
2. Premere  per passare tra le impostazioni.
3. Ruotare  per impostare un valore.
4. Premere  per salvare l'impostazione.



### Passaggio tra modalità automatica e manuale

**Modalità manuale:** imposta manualmente una modalità di movimento dell'acqua e un livello di flusso per la Tua Duo Turbine.

**Modalità automatica:** Un insieme di programmi con modalità di movimento programmabile e livello di flusso che verrà ciclicato ogni 24 ore.

L'interfaccia della Modalità Manuale

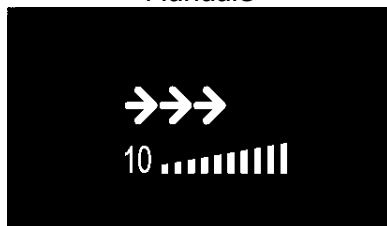



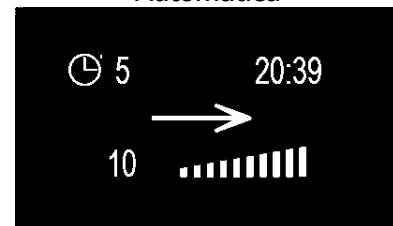

L'interfaccia della Modalità Automatica



### Introduzione all'interfaccia



Interfaccia principale

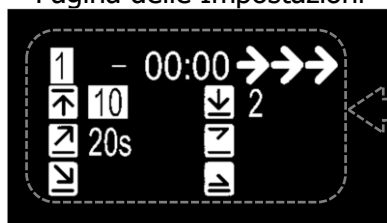

-  5 Punto temporale
-  20:39 Ora attuale
-  Modo di movimento dell'acqua
-  10 Livello di Flusso
-  Indicatore di Livello

Pagina delle Impostazioni



-  1 - 00:00 Punto temporale (Totale 24)
-  Modo di movimento dell'acqua
-  10 20s 2 Variabili configurabili

# Istruzioni Per L'Uso

## Icona dello schermo OLED

### Modo di movimento dell'acqua



Modalità a velocità costante



Modalità a pulsazione



Modalità casual



Modo a Pulsazione Avanzato

### Variabili



Massima flusso d'acqua



ccelerazioneDurata di accelerazione



Durata massima di flusso



Minima flusso d'acqua



Durata di decelerazione



Durataminima di flusso

### Illustrazione delle variabili

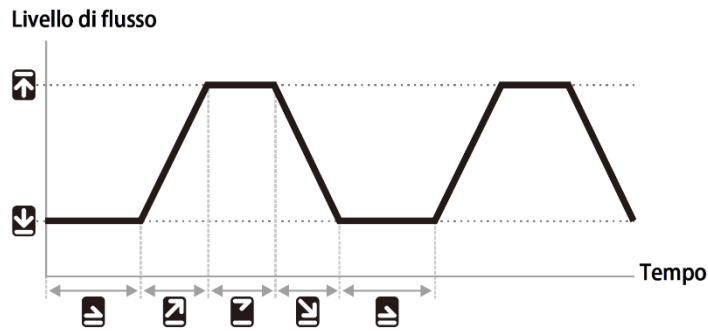

Italiano

### Illustrazione della modalità di movimento dell'acqua



Modalità a velocità costante

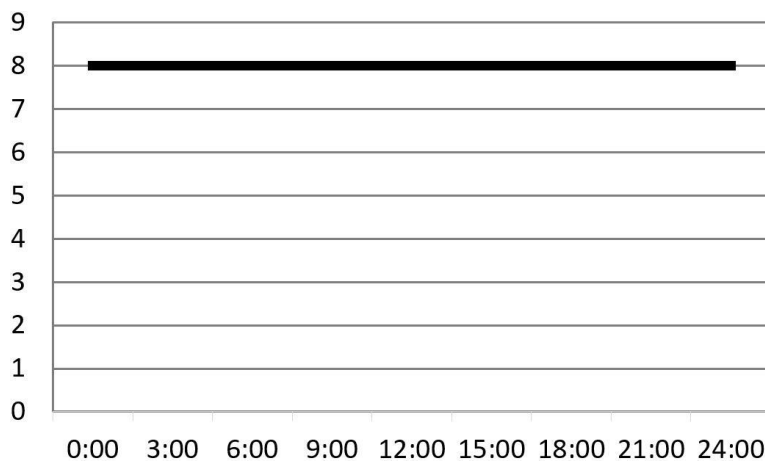

### Variables configurables

Campo di portata: 1-10



livello 8



N/A



N/A



N/A



N/A



N/A

# Istruzioni Per L'Uso

## ➔➔➔ Modalità a pulsazione

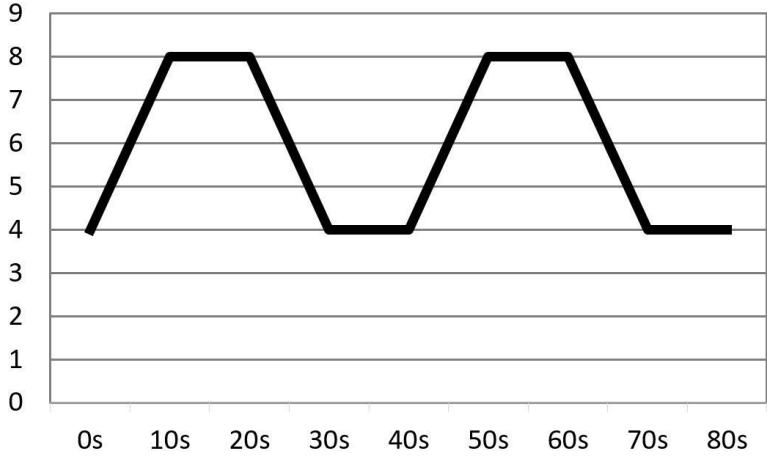

### Campo di portata

Campo di portata: 1-10    Intervallo di tempo: 2-30s

⬆️	livello 8	⬆️	10s	⬆️	N/A
⬇️	livello 4	⬇️	N/A	⬇️	N/A
⬆️	=	⬇️	=	⬆️	=
⬆️		⬇️		⬆️	

⬆️ = ⬇️ = ⬆️ = ⬆️ = 10s

## ➔➔➔ Modalità casual

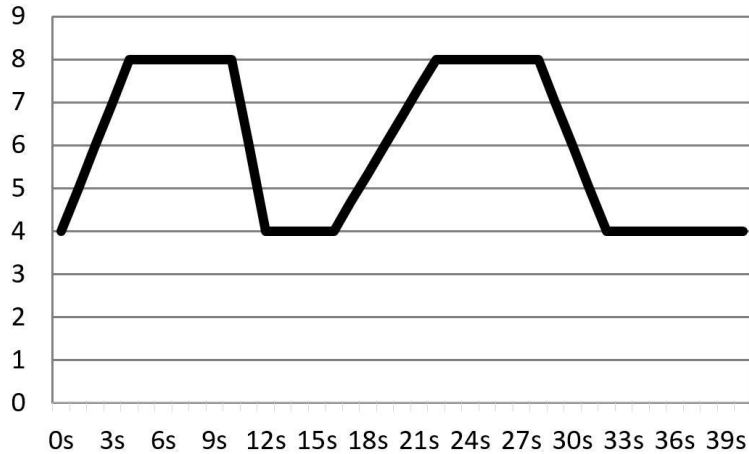

### Variables configurables

Massima portata: 2-10, Portata minima: 1-9

⬆️	livello 8	⬆️	N/A	⬆️	N/A
⬇️	livello 4	⬇️	N/A	⬇️	N/A







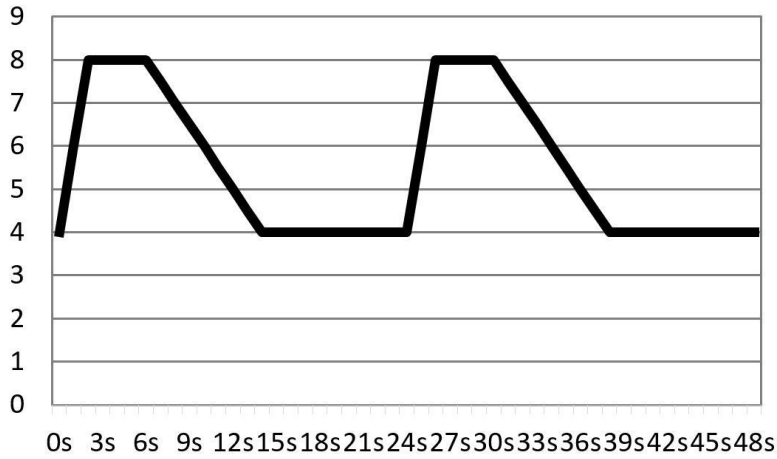

# Istruzioni Per L'Uso

## Modo a Pulsazione Avanzato



### Variables configurables

Campo di portata: 1-10		Intervallo di tempo: 2s-5m	
	livello 8		2s
	livello 4		8s
			4s
			20s

Italiano

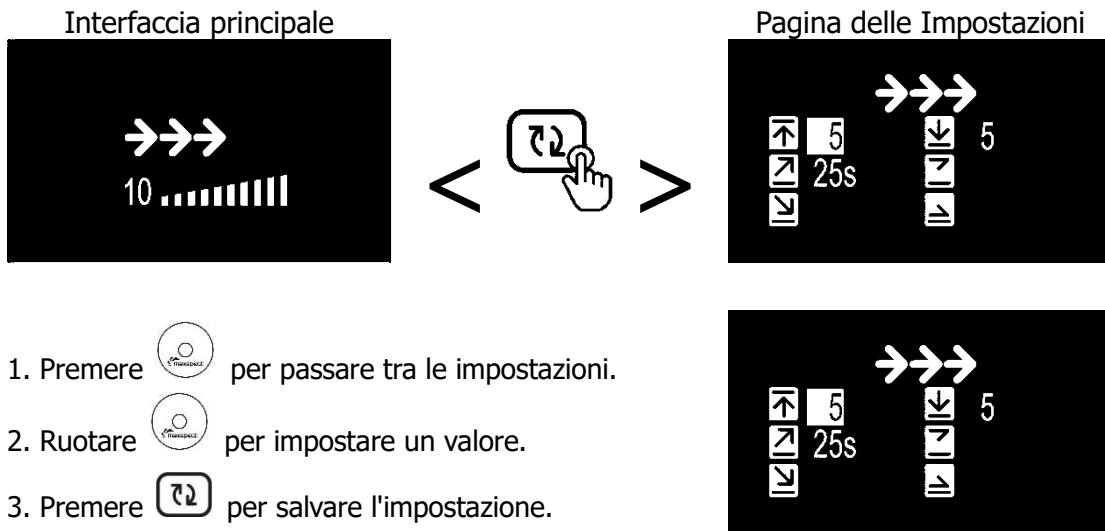

### Modalità Manuale

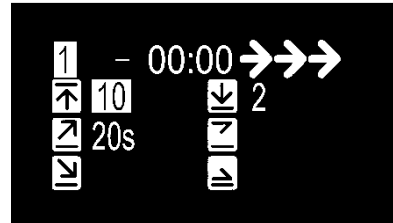
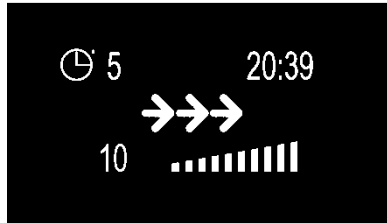

## Istruzioni Per L'Uso

### Modalità automatica





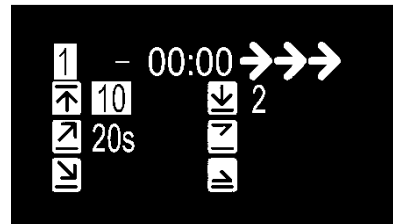

1. Premere  per passare tra le impostazioni.
2. Ruotare  per impostare un valore.
3. Premere  per salvare l'impostazione.

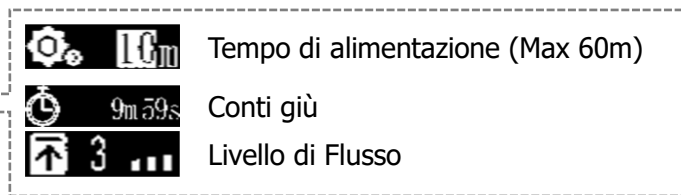

### Modalità di alimentazione



In un'interfaccia principale, premere  per entrare in Modalità Alimentazione.

1. Premere  per attivare l'impostazione.
2. Premere  per passare tra le impostazioni.
3. Ruotare  per impostare un valore.
4. Premere  per salvare l'impostazione.

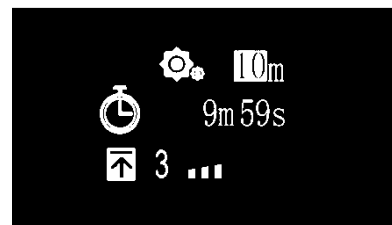
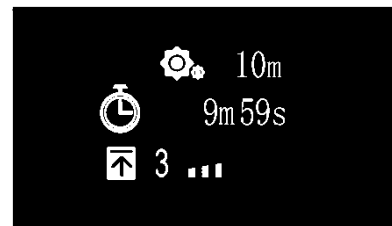

## Istruzioni di manutenzione

### Configurazione del sistema

L'impostazione del sistema contiene un insieme di funzioni che consentono di effettuare la manutenzione sull'apparecchio.

Per accedere alla pagina di configurazione del sistema, prima spegnere l'apparecchio, quindi tenere premuto il selettore di controllo accendendo l'apparecchio. Continuare a tenere premuto il selettore di controllo fino a visualizzare la pagina di impostazione del sistema sul monitor OLED.

Sulla schermata "System Setup" appaiono 5 funzioni:

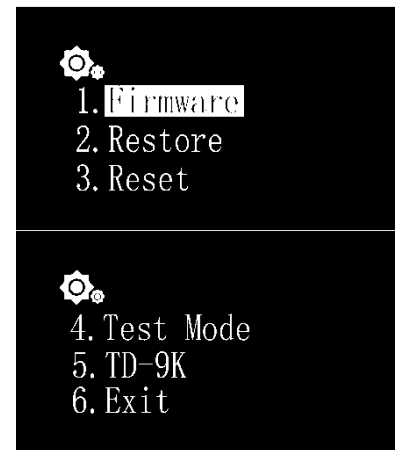

1. Firmware
2. Restore
3. Reset
4. Test Mode
5. Model Number
6. Exit



Italiano

#### 1. Firmware

Questa funzione permette all'utente di aggiornare il firmware.

1. Ruota  e seleziona "Firmware".
2. Premi  per avviare l'aggiornamento del firmware.
  1. In caso di assenza della scheda micro SD, o quando il firmware sulla SD non è valido, appare la dicitura: "NO SD Card" o "Wrong File".
  2. In caso contrario verranno visualizzati gli aggiornamenti del firmware.

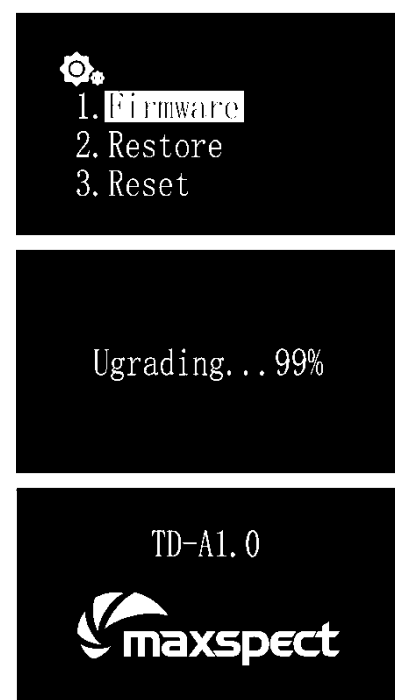

Una volta aggiornato il firmware la plafoniera ripartirà automaticamente e verrà visualizzato il nr della nuova versione del firmware.



## Istruzioni di manutenzione

### 2. Restore

Questa funzione consente di ripristinare il firmware nella sua versione originale. Dopo aver completato il ripristino del firmware, verrà riavviato automaticamente e il numero di versione firmware verrà visualizzato sullo schermo.

1. Ruota  e seleziona "Restore".
2. Premi  per ristabilire il firmware.



### 3. Reset

Questa funzione consente di ripristinare l'apparecchio alle impostazioni di fabbrica. Dopo aver finito di ripristinare l'apparecchio, si riavvia automaticamente.

1. Ruota  e seleziona "Reset".
2. Premi  per avviare il reset.





### 4. Test Mode

Questa funzione permette all'utente di effettuare il test della plafoniera cui finalità è quella di aiutare il nostro servizio clienti a diagnosticare la stessa. **Questa operazione deve essere effettuata dall'utente solo a seguito della richiesta da parte del servizio clienti di effettuare determinati test sulla plafoniera.**

### 5. Model Number

Questa funzione visualizzerà il numero di modello della plafoniera necessario anche come ID nel caso in cui la Turbine Duo è connessa ad un dispositivo iOS o Android a mezzo sistema Syna-G. **In circostanze normali questo valore non deve essere modificato.**

### 6. Exit

1. Ruota  e seleziona "Exit".
2. Premere  per riavviare l'apparecchio.

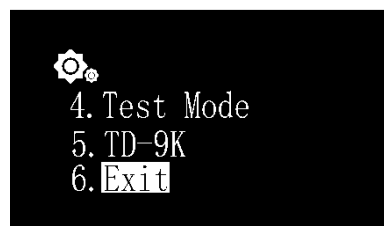

## Termini di garanzia

Maxspect (HongKong) Limited garantisce tutti i prodotti della pompa Maxspect™ Turbine Duo DC, per un periodo di 12 mesi dalla data di acquisto. Se un difetto di produzione si presenta durante il periodo di garanzia, Maxspect Ltd. a sua discrezione, riparerà (usando componenti nuovi o ricostruiti) o sostituirà (con una nuova unità o rigenerate) il prodotto senza alcun costo.

LA GARANZIA NON SI APPLICA AL PRODOTTO SE È STATO DANNEGGIATO DA USO IMPROPRIO, ALTERAZIONE, INCIDENTE, USO O FUNZIONAMENTO IMPROPRIO, SE SONO EFFETTUATE RIPARAZIONI NON AUTORIZZATE.

### **ESCLUSIONE DEI DANNI INDIRETTI E ACCIDENTALI:**

L'utilizzatore dei prodotti della Maxspect Ltd. non ha diritto ad alcun risarcimento danni diretti o indiretti, senza limitazione, derivanti da: disagi, danni ai beni personali, telefoni, le perdite materiali ecc... Questa garanzia conferisce diritti legali specifici.

MAXSPECT LTD. NON FORNISCE ALCUNA GARANZIA O DICHIARAZIONE, ESPLICITA O IMPLICITA, RISPETTO ALLA QUALITÀ DEL PRODOTTO, PRESTAZIONI, COMMERCIALIZZABILITÀ O IDONEITÀ PER UNO SCOPO DIVERSO DA QUELLO INDICATO. DI CONSEGUENZA QUESTO PRODOTTO VIENE VENDUTO, COSÌ COME È E L'ACQUIRENTE SI ASSUME IL RISCHIO SULLA QUALITÀ E PRESTAZIONI.

In nessun caso la MAXSPECT LTD potrà essere ritenuta responsabile per danni diretti, indiretti, speciali, incidentali o conseguenti derivanti da qualsiasi problema del prodotto o la documentazione.

La garanzia, ed i rimedi di cui sopra sono esclusivi e sostituiscono tutti gli altri, orali o scritti, espressi o impliciti. In nessun caso qualsiasi commerciante, agente, impiegato è autorizzato ad apportare modifiche, estensioni o aggiunte alla presente garanzia.

Alcuni stati non consentono l'esclusione o la limitazione delle garanzie implicite o la responsabilità per danni incidentali o consequenziali, pertanto la suddetta limitazione o esclusione potrebbe non applicarsi a Voi.

### Nota:

Per le ultime specifiche di Turbine Duo DC Pump, visitare: [www.maxspect.com](http://www.maxspect.com)



## ***Prezado Cliente,***

Obrigado por adquirir este produto.

Para um melhor desempenho e segurança, por favor leia cuidadosamente estas instruções.

### **User Memo:**

Data da Compra:	_____
Nome Loja:	_____
Endereço Loja:	_____ _____
Website Loja:	_____
Email Loja:	_____
Telefone Loja:	_____

Português

### **Por favor, visite-nos no Facebook ou Twitter!**



<https://www.facebook.com/Maxspect>



<http://twitter.com/maxspectled>

## Conteúdo da Embalagem

Por favor, analise o conteúdo da embalagem.

### Componentes principais

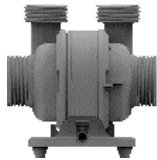

Bomba



Controlador

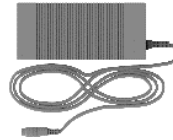

Fonte de Energia



Cabo de energia



Adaptador de Bateria

### Peças Sobressalentes de Entrada

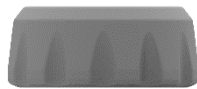

1.  $\Phi 58\text{mm}$  2pcs

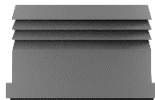

2. 1" 2pcs

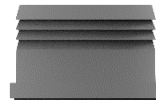

2A.  $\Phi 32\text{mm}$  2pcs



3.  $\Phi 40\text{mm}$  2pcs



4. 2pcs



5. 2pcs

### Peças Sobressalentes Duo de Saída

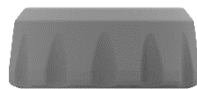

6.  $\Phi 51\text{mm}$  2pcs

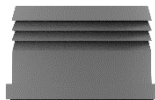

7.  $\frac{3}{4}"$  2pcs

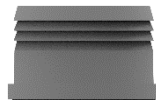

7A.  $\Phi 25\text{mm}$  2pcs



7B.  $\Phi 16\text{mm}/\frac{1}{2}"$  2pcs  
 $\Phi 20\text{mm}/\frac{3}{4}"$  2pcs



7C.  $\Phi 25\text{mm}/1"$  2pcs  
 $\Phi 32\text{mm}/\frac{1}{4}"$  2pcs



8.  $\Phi 32\text{mm}$  2pcs



## Conteúdo da Embalagem

### Peças Sobressalentes Tubo-Y

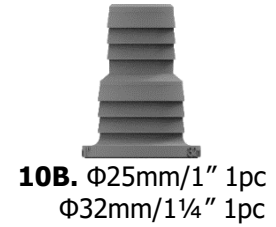
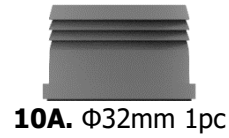
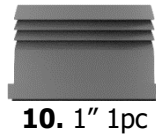
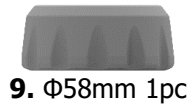

### Peças Sobressalentes de Saída Simples

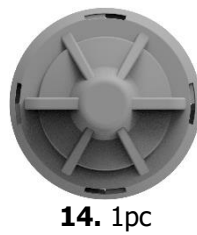

Antes de usar seu DC pump Maxspect™ Turbine Duo por favor leia este manual de instruções cuidadosamente. Tenha cuidado e siga corretamente todas as instruções descritas.

Mantenha sempre ao alcance este manual para eventual consulta.

### LEIA E SIGA TODAS AS INSTRUÇÕES DE SEGURANÇA

1. PERIGO - Para evitar possíveis choques elétricos, deve-se ter um cuidado especial, uma vez que a água é utilizada no uso de equipamentos de aquário. Para cada uma das seguintes situações, não tente reparar sozinho; Devolva o aparelho a uma assistência técnica autorizada para serviço ou descarte o aparelho.
  - a) Se o aparelho apresentar algum sinal de vazamento de água anormal, desconecte-o imediatamente da fonte de alimentação.
  - b) Examine cuidadosamente o aparelho após a instalação. Não deve ser conectado se houver água em peças que não se destinem a ser molhadas.
  - c) Não utilize nenhum aparelho se o cabo de energia ou plug estiver danificado, com defeito ou tenha sido descartado ou danificado de qualquer maneira.
  - d) Para evitar a possibilidade de água no plug de energia ou tomada, use a tomada ao lado do aquário preferencialmente instalada na parede e com proteção. Adote ao cabo uma posição de "gotejamento", conforme mostrado na figura, deve ser organizado pelo usuário para cada cabo que conecta um aparelho de aquário a uma tomada. O "gotejamento" é aquela parte do cabo abaixo do nível da tomada, ou do conector (se for utilizado um cabo de extensão), para evitar que a água percorra o cabo e entre em contato com a tomada. Se o plugue ou conector ficar molhado, NÃO desligue o cabo. Desconecte o fusível ou disjuntor que fornece energia ao aparelho. Em seguida, desconecte e examine a presença de água na tomada.

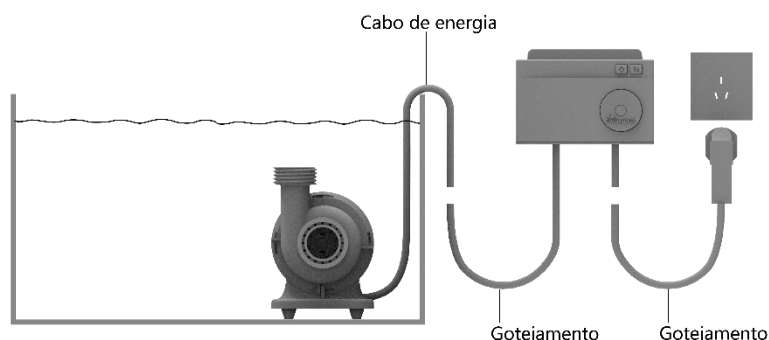

2. Uma supervisão próxima é necessária quando qualquer aparelho é usado por crianças ou perto delas.
3. Para evitar lesões, não entre em contato com partes móveis ou peças quentes, como aquecedores, refletores, lâmpadas e outros.

## Precauções

- Desligue sempre um aparelho de uma tomada quando não estiver em uso, antes de colocar ou retirar peças e antes de limpar. Nunca puxe pelo cabo para retirar da tomada. Segure o plug e puxe para desconectar.
- Não use um aparelho para uma função diferente do previsto. O uso de acessórios não recomendados / vendidos pelo fabricante do aparelho pode causar uma condição insegura de uso.
- Não instale nem armazene os aparelhos onde ele estará exposto ao clima ou a temperaturas abaixo do congelamento.
- Certifique-se de que o aparelho montado em um aquário esteja instalado de forma segura antes de operá-lo.
- Leia e observe todos os avisos importantes no aparelho.
- Se for necessário um cabo de extensão, deve-se usar um cabo com uma classificação apropriada. Um cabo classificado para menos amperes ou watts do que a classificação do aparelho pode superaquecer e causar problemas.
- O cabo de energia deve ser protegido contra danos, nunca coloque nada com peso sobre eles. Nunca segure o plug ou o fio se a sua mão estiver molhada e segure sempre no plug ao conectar ou desconectá-lo.
- O aparelho é projetado para ser usado somente na água, todo o corpo do aparelho deve ser submerso na água.

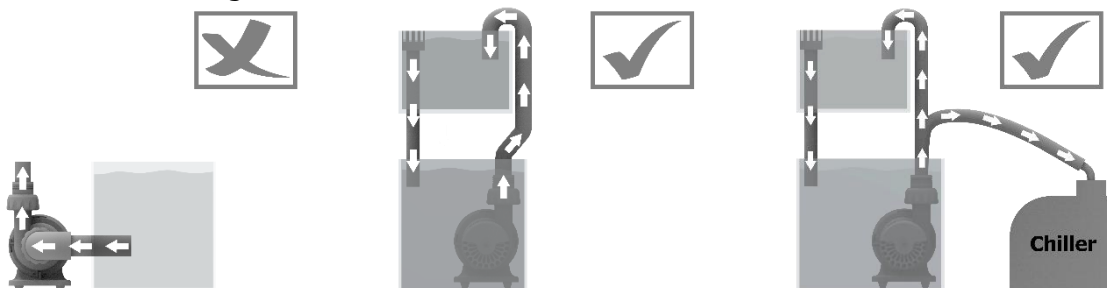

- Para manter o bom desempenho do aparelho, deve ser instalado onde a distância vertical entre a saída e a entrada é inferior a 2 m.

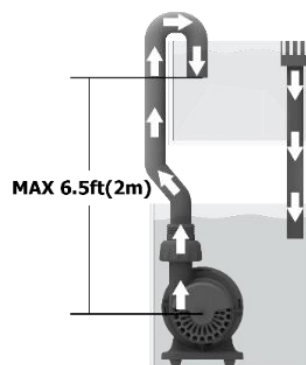

## Manutenção Regular da Bomba

### Manutenção do Aparelho

A Bomba Turbine Duo DC foi projetada para operar facilmente com pouca atenção após a configuração inicial. No entanto, devido às duras condições de um aquário de água salgada e ao acúmulo resultante de algas e outras matérias orgânicas, é aconselhável limpar a bomba para garantir a longevidade do aparelho. Maxspect recomenda fazer uma limpeza a cada 6 meses ou, com maior frequência se necessário. Isso pode ser conseguido abrindo o invólucro do impulsor e escovando suavemente o impulsor e dentro da caixa com uma escova macia sob água corrente. Se houver acúmulo de cálcio, pode ser necessário embeber essas partes em uma solução ácida suave, como o vinagre. Não use ácidos fortes, porque estes podem danificar os componentes. Após a limpeza, volte a montar o aparelho.

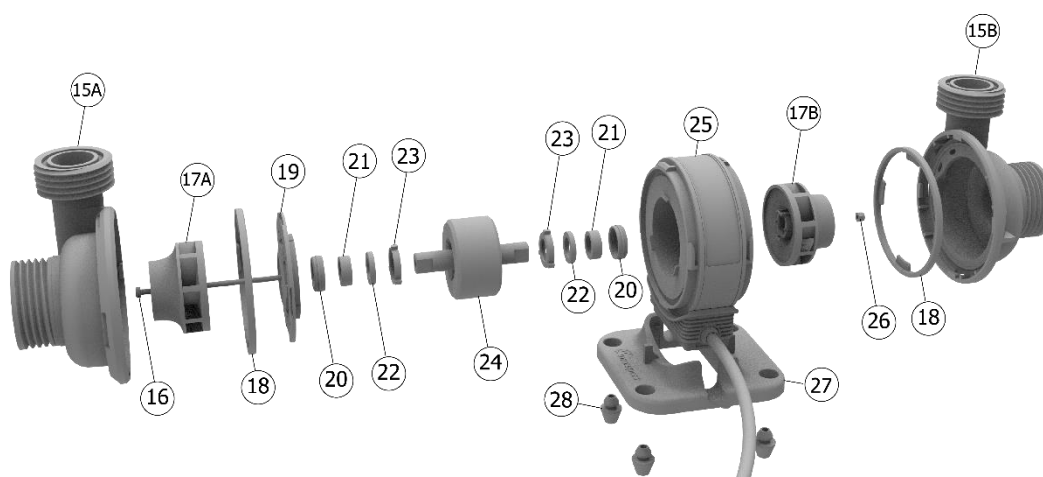

15A. Local do Impeller (A)

15B. Local do Impeller (B)

16. Parafuso

17A. Impeller(A)

17B. Impeller(B)

18. Selo de Silicone

19. Tampa do Rotor

20. Coxim de Silicone

21. Rolamento

22. Rolamento Ceramico

23. Coxim de Silicone

24. Rotor

25. Estator

26. Porca de parafuso

27. Base da Bomba

28. Coxim de Silicone

# Instalação

## Instalação de Entrada

Você pode alternar o acoplamento de união entre 2 / 2A para caber em um tubo de tamanho diferente, enquanto Turbine Duo funciona como uma bomba de circuito fechado.

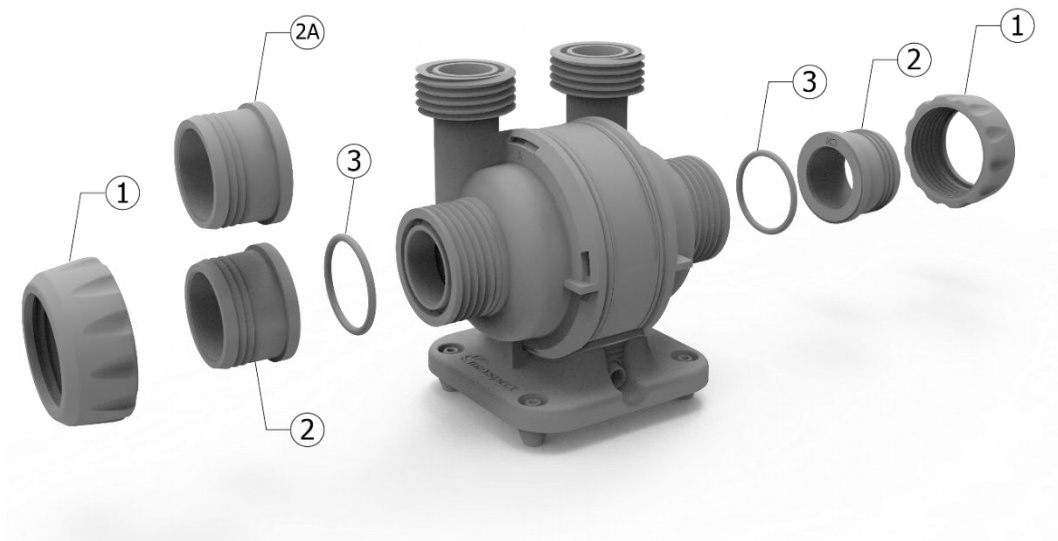

Ou você também pode instalar duas redes de admissão enquanto corre como uma bomba de retorno.

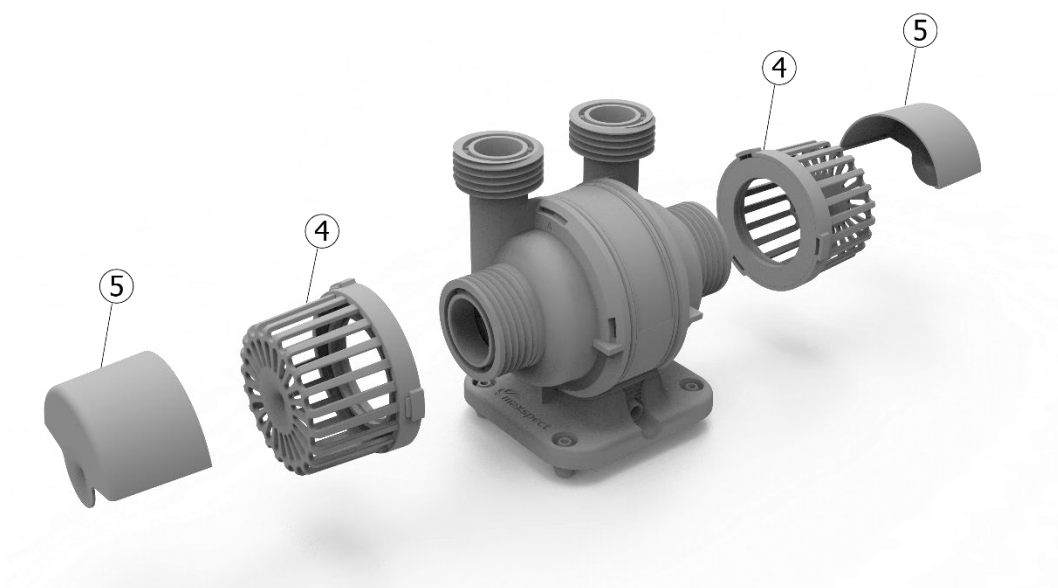

Português

## Instalação de Saída

**Duas Saídas:** Mude os acoplamentos de união entre 7 / 7A / 7B / 7C para um tubo ou mangueira de tamanho diferente.

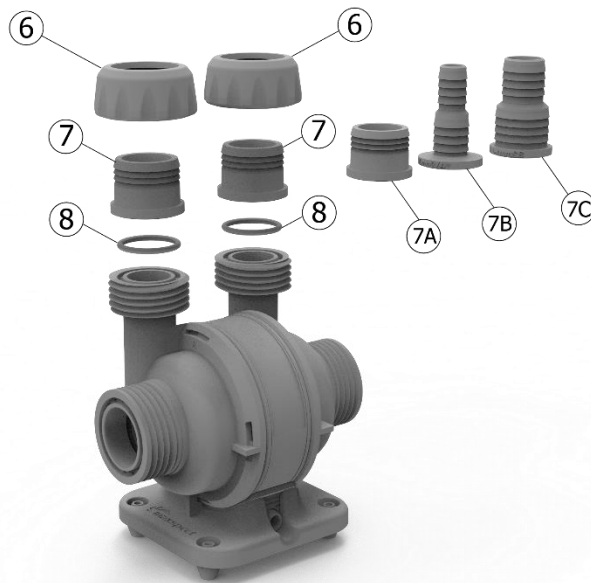

Português

**Saída combinada usando Tubo-Y:** Mude os acoplamentos de união entre 10 / 10A / 10B para um tubo ou mangueira de tamanho diferente.

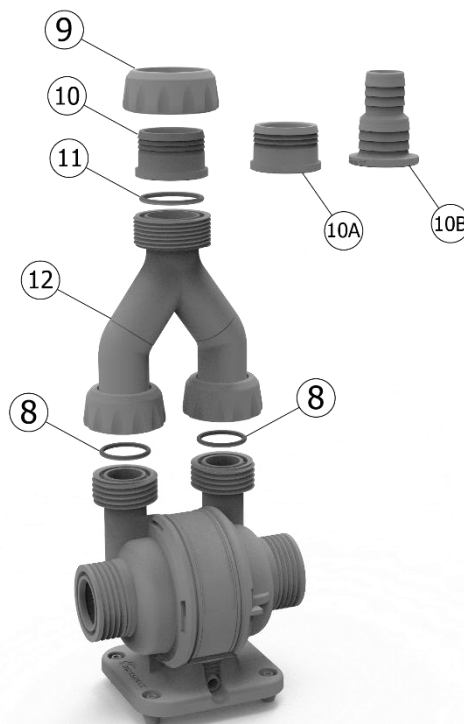

# Instalação

**Saída Simples:** Você também pode substituir a carcaça do impulsor B pela tampa para torná-la uma bomba DC de saída única.

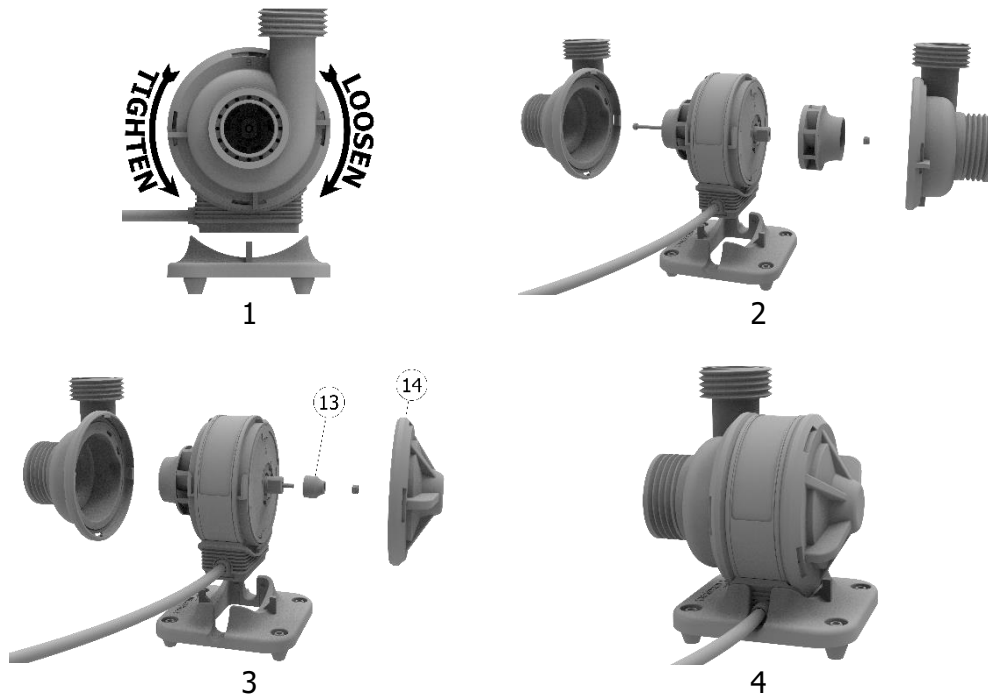

**Importante:** somente a carcaça do impulsor B pode ser substituída pela tampa. A base da bomba deve ser instalada antes de colocar em uso.

Português

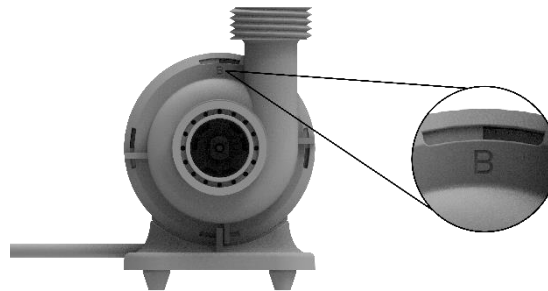

## Direção de Saída

Tanto as caixas de impulsor A e B podem ser instaladas em três direções.



## Instruções de operação

### A Unidade de Controle Turbine Duo

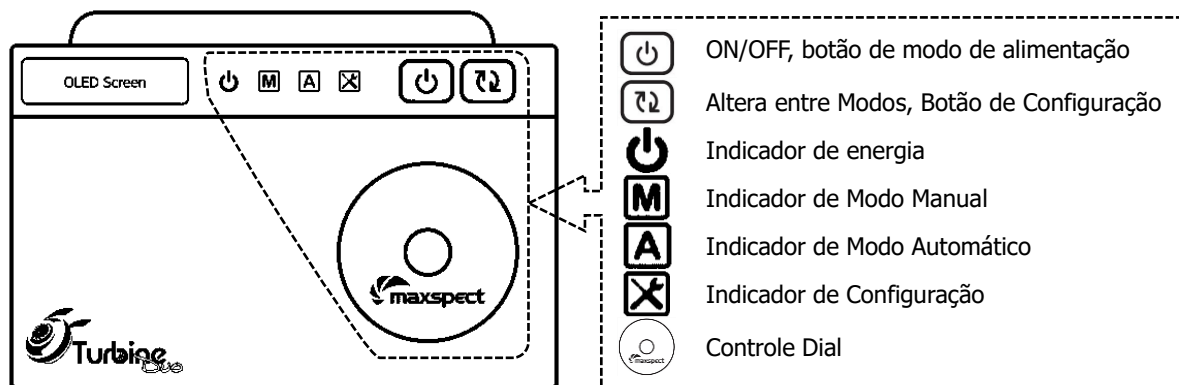

### Ligar / Desligar a Turbine Duo

Pressione e mantenha pressionado o botão ON / OFF acima de 4s para ligar ou desligar o aparelho. Enquanto o aparelho estiver desligado, a bomba deixa de funcionar, os indicadores e a tela OLED do controlador serão desligados. No entanto, se o aparelho estiver conectado a um ICV6 (vendido separadamente), ele ainda pode ser ativado pela aplicação Syna-G.

### Inicialize sua Turbine Duo

Antes de usar o aparelho, há algumas configurações básicas que você precisa fazer para a Turbine Duo.

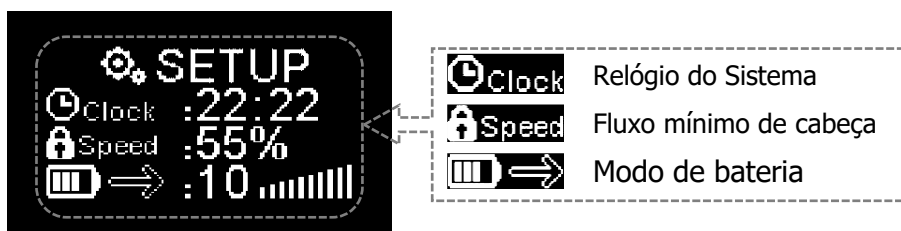

**Clock:** Configure o relógio do sistema para combinar com a hora local.

**Speed:** configure o fluxo mínimo para a bomba em todos os tempos. Isso significa que o ajuste do fluxo mínimo de água para todos os modos de movimento da água será calculado com base neste valor. O intervalo de fluxo mínimo ajustável está entre 1% e 90%.



**Modo de bateria:** configure a velocidade de trabalho da bomba enquanto ele é alimentado por uma bateria de backup. O produto é embalado com um adaptador de interruptor de energia que possui dois cabos de fonte de alimentação, uma extremidade se conecta à unidade de alimentação oferecida pela Maxspect, a outra extremidade se conecta a uma bateria DC 12v (vendida separadamente). Quando a alimentação da PSU é cortada, a fonte de energia será trocada automaticamente para a bateria.





## Instruções de operação

1. Enquanto a tela OLED estiver ativada, pressione os botões

 e  simultaneamente para entrar na página de configuração.

2. Pressione  para alternar entre as configurações.

3. Rotacione  para definir um valor.

4. Pressione o  para salvar a configuração.



### Alternar entre o modo automático e manual

**Modo manual:** ajuste manualmente o modo de movimento da água e o nível de fluxo da Turbine Duo.

**Modo Automático:** um conjunto de programas com modo de movimento de água programável e nível de fluxo que será rodado a cada 24 horas.

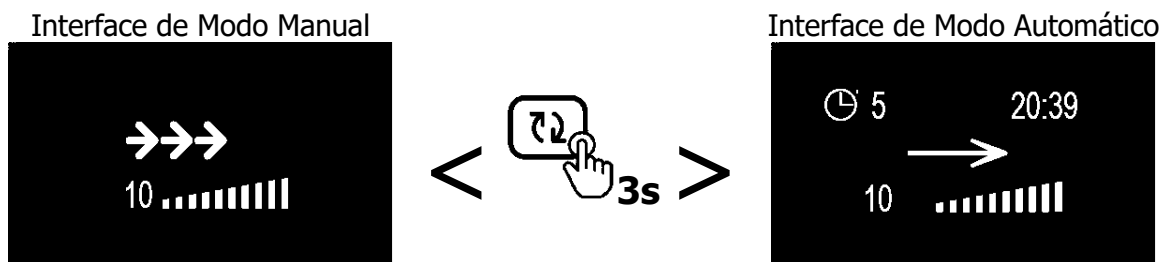

Português

### Interface Inicial

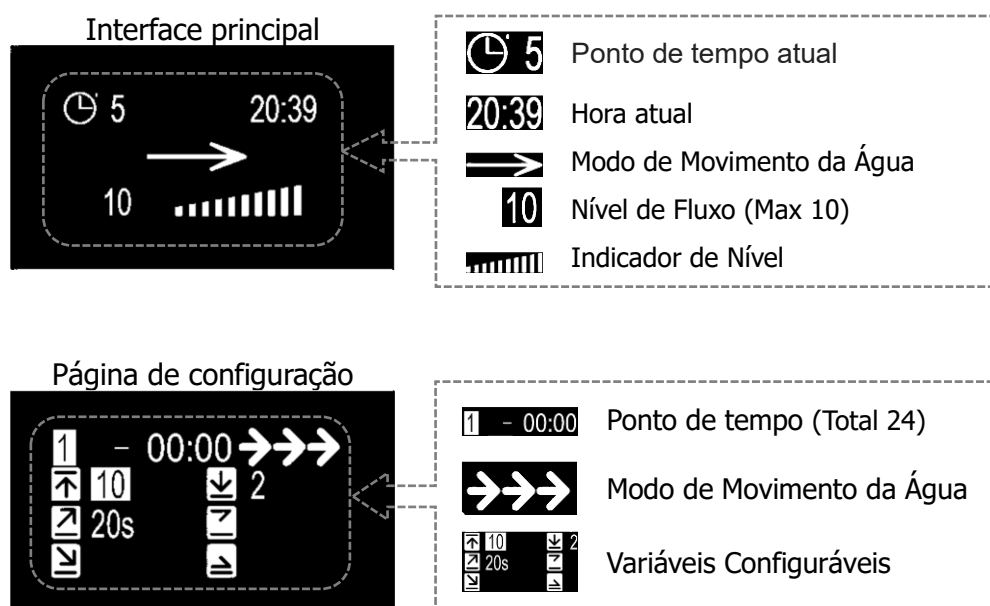

## Instruções de operação

### Ícone da tela OLED

#### Modos de movimento da água



Modo de velocidade constante



Modo de Pulso



Modo Randomico



Modo Pulsação Avançado

#### Variáveis



Fluxo máximo



Tempo de subida



Tempo de fluxo máximo



Fluxo mínimo



Tempo de relaxamento



Tempo de fluxo minimo

#### Variáveis ilustradas

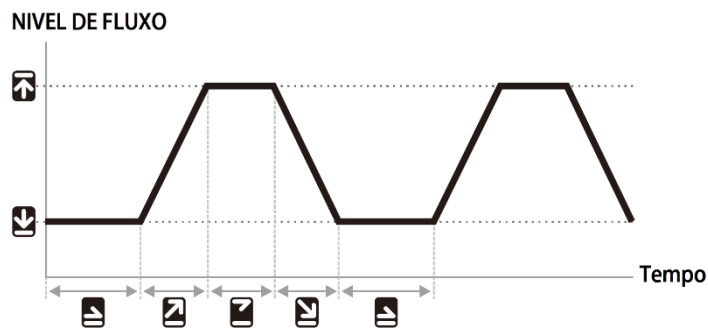

Português

#### Modos de movimento da água ilustradas



Modo de velocidade constante

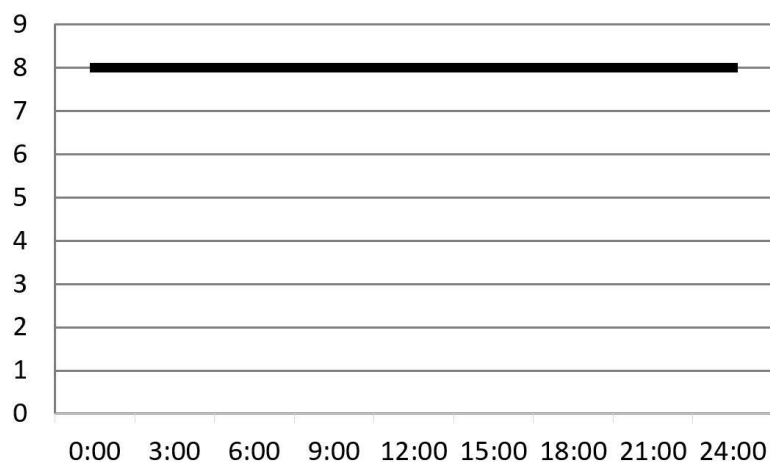

#### Variáveis Configuráveis

Escala de fluxo: 1-10



Nível 8



N/A



N/A



N/A



N/A



N/A

# Instruções de operação



## Modo de Pulso

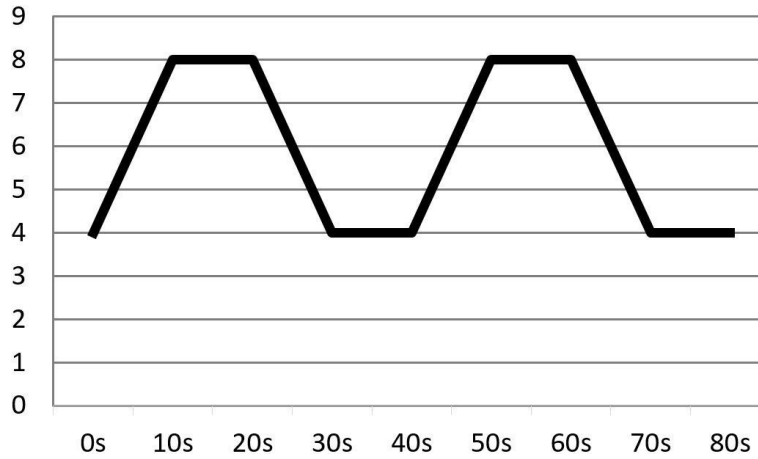

### Variáveis Configuráveis

Escala de fluxo: 1-10    Intervalo de tempo: 2-30s

	Nível 8		10s		N/A					
	Nível 4		N/A		N/A					
	=		=		=		=		=	10s

Português



## Modo Randomico

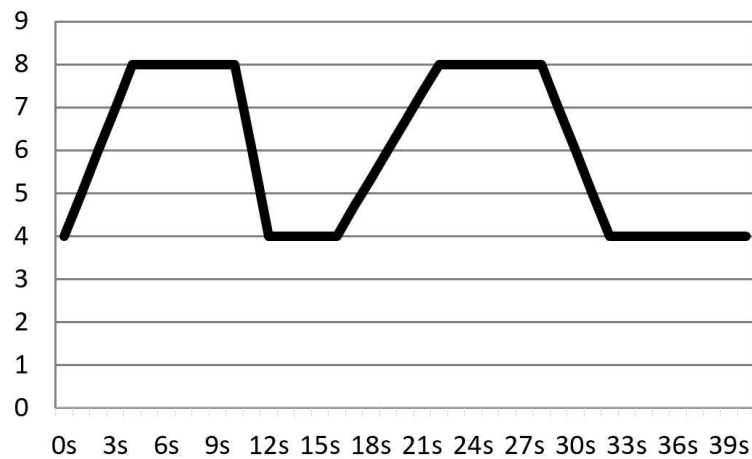

### Variáveis Configuráveis

Max Escala de fluxo: 2-10, Min Escala de fluxo: 1-9

	Nível 8		N/A		N/A
	Nível 4		N/A		N/A

# Instruções de operação



## Modo Pulsação Avançado

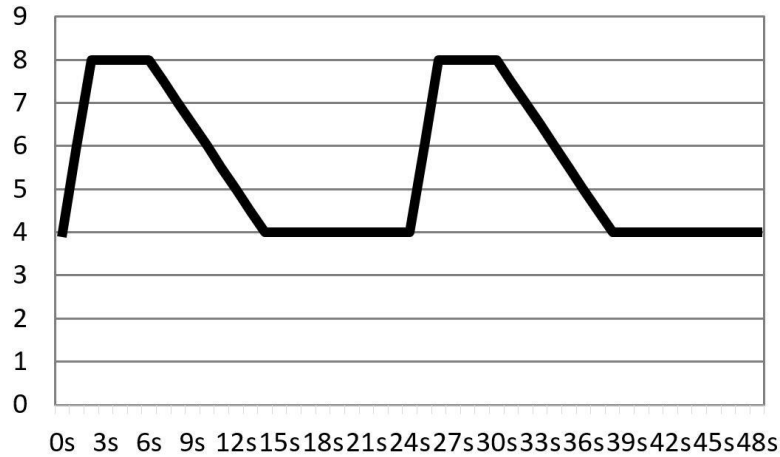

## Variáveis Configuráveis

Escala de fluxo: 1-10		Intervalo de tempo: 2s-5m	
	Nível 8		2s
	Nível 4		8s
			4s
			20s

Português

## Modo manual

Interface Principal

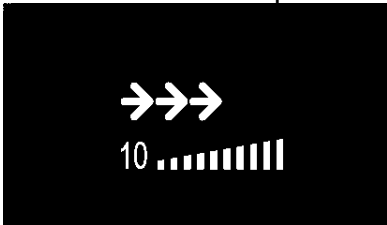

< >

Página de Configuração

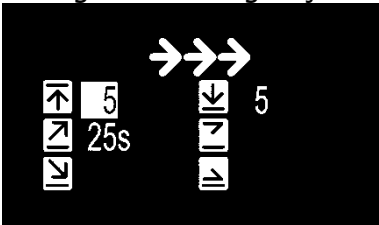



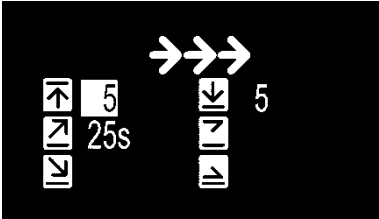

1. Pressione para alternar entre as configurações.
2. Rotacione para definir um valor.
3. Pressione o para salvar a configuração.

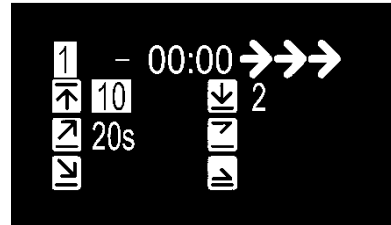
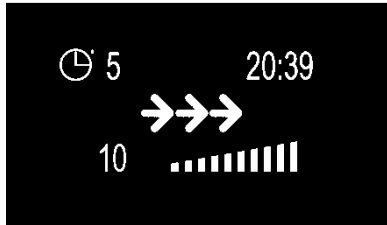

# Instruções de operação

## Modo Automático





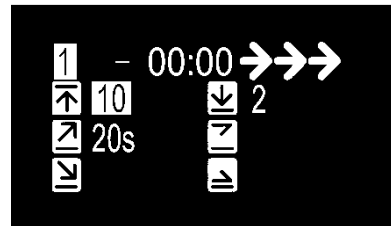

1. Pressione  para alternar entre as configurações.
2. Rotacione  para definir um valor.
3. Pressione o  para salvar a configuração.

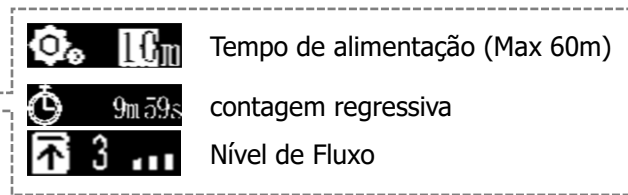

## Modo de alimentação



Na interface principal, pressione  para entrar no Modo de Alimentação.

1. Pressione  para ativar a configuração.
2. Pressione  para alternar entre as configurações.
3. Rotacione  para definir um valor.
4. Pressione o  para salvar a configuração.

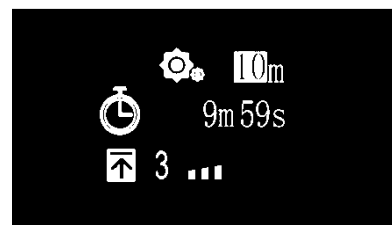
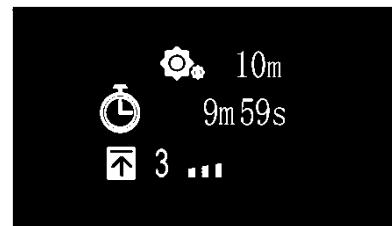

## Instruções de Manutenção

### System Setup

A Configuração do Sistema possui um conjunto de funções que permitem ao usuário executar a manutenção no dispositivo.

Para entrar na página de Configuração do Sistema, primeiro desligue o dispositivo elétrico e, em seguida, pressione e mantenha pressionado o botão de controle enquanto o dispositivo volta a ser ligado. Mantenha pressionado o botão de controle até que a página de configuração do sistema seja exibida no monitor OLED.

Existem 5 funções na tela Configuração do Sistema.

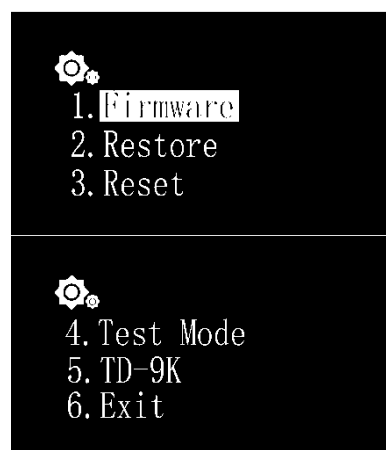

1. Firmware (Firmware)
2. Restore (Restaurar)
3. Reset (Resetar)
4. Test Mode (Modo Teste)
5. Model Number (Numero do Modelo)
6. Exit (Sair)



Português

#### 1. Firmware

Esta função permite ao usuário atualizar o firmware.

1. Rotacione  para selecionar "Firmware".
2. Pressione  para iniciar a atualização do firmware.

1. Quando não houver um cartão SD ou um firmware inválido no cartão SD, "NO SD Card" ou "Wrong File" será mostrado.
2. Caso contrário, o progresso da atualização do firmware será mostrado.

Após atualização do firmware com sucesso, o dispositivo será reiniciado automaticamente e o novo número de versão do firmware será mostrado.

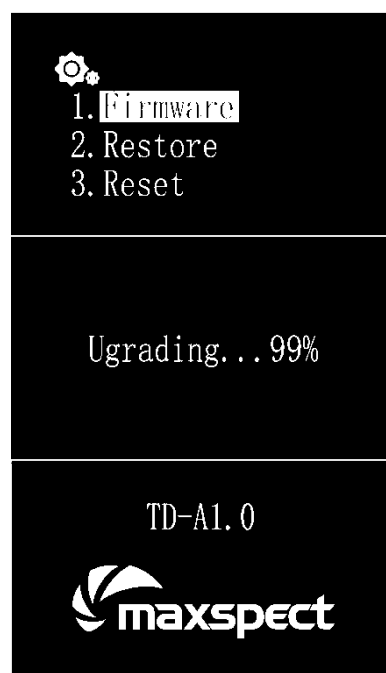

## Instruções de Manutenção

### 2. Restore

Esta função permite ao usuário restaurar o firmware para sua versão original de fábrica. Após concluir a restauração do firmware, o dispositivo será reiniciado automaticamente e o número da versão do firmware será mostrado.

1. Rotacione  para seleccionar "Restore".
2. Pressione  para restaurar o firmware.



### 3. Reset

Esta função permite ao usuário reinicializar o dispositivo de volta às suas configurações de fábrica. Depois de terminar de redefinir o dispositivo, ele será reiniciado automaticamente.

1. Rotacione  para seleccionar "Reset".
2. Pressione  para redefinir a fábrica.



Português



### 4. Test Mode

Esta função permite que o usuário coloque a luminária no modo de teste, o que ajudaria nosso representante de atendimento ao cliente diagnosticar o dispositivo. **Isso só deve ser feito pelos usuários quando informado pelo revendedor autorizado ou representante do cliente para realizar determinado teste na luminária.**

### 5. Model Number

Esta função exibirá o número do modelo da utensílio, que também serve como nome do ID quando a Turbine Duo está conectada a um dispositivo iOS ou Android através do sistema Syna-G. **Em circunstâncias normais, este valor não poderá ser alterado.**

### 6. Exit

1. Rotacione  para seleccionar "Exit".
2. Pressione  para reiniciar o dispositivo.

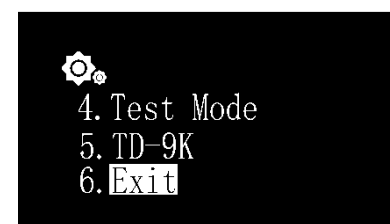

Maxspect Ltd. garante ao produto Maxspect™ a garantia de 12 meses relacionados com defeitos de fabricação, sendo contados a partir da data de compra. Se houver algum defeito no produto durante o período de garantia, a Maxspect realizará o reparo no equipamento (com peças novas) sem nenhum custo.

A garantia não se aplica ao produto que foi submetido a mau uso, manipulado por pessoas não autorizadas (técnicos ou não), usado de forma inadequada (instalação, local inadequado), alteração na configuração dos leds ou qualquer tipo de queda do produto que possa causar danos ao mesmo.

### **ISENÇÃO DE DANOS E CONSEQÜÊNCIAS:**

Você e qualquer outro usuário dos produtos Maxspect Ltd. não terá direito a quaisquer danos acidentais, incluindo, sem limitação, perda de uso da unidade, inconveniência, danos a bens pessoais, telefonemas, perda de renda ou lucros. Esta garantia lhe dá direitos legais específicos.

MAXSPECT LTD. NÃO FAZ NENHUMA GARANTIA OU REPRESENTAÇÃO, EXPRESSA OU IMPLÍCITA, COM RELAÇÃO À QUALIDADE DO PRODUTO, DESEMPENHO, COMERCIALIZAÇÃO OU ADEQUAÇÃO PARA UM DETERMINADO PROPÓSITO. COMO RESULTADO, ESTE PRODUTO, É VENDIDO "COMO ELE É", E VOCÊ O COMPRADOR ASSUME O RISCO TOTAL COM A SUA QUALIDADE E DESEMPENHO.

EM HIPÓTESE ALGUMA MAXSPECT LTD SÃO RESPONSÁVEIS DIRETOS, INDIRETOS, ESPECIAIS, INCIDENTAIS OU CONSEQÜENCIAIS DECORRENTES DE QUALQUER DEFEITO NO PRODUTO OU SUA DOCUMENTAÇÃO.

A garantia, aviso legal, e soluções estabelecidas acima são exclusivas. A substituir todos os outros, oral ou escrita, expressa ou implícita. Em nenhum momento, quaisquer negociantes Maxspect Ltd., agentes ou funcionários serão autorizados a fazer qualquer modificação, extensão ou acréscimo a esta garantia.

Alguns estados não permitem a exclusão ou limitação de garantias implícitas ou de responsabilidade por danos acidentais ou consequentes, portanto a limitação ou exclusão acima pode não se aplicar a você.



## Especificações

### **ATENÇÃO:**

Para especificações mais recentes dos Turbine Duo DC pump, tipos e espectro de cores, por favor, visite nosso website em [www.maxspect.com](http://www.maxspect.com)



## ***Szanowny Kliencie,***

Dziękujemy i gratulujemy za zakup naszego produktu.

Prosimy o uważne przeczytanie poniższych instrukcji w celu uzyskania optymalnej wydajności i bezpieczeństwa.

### **User Memo:**

Data zakupu: \_\_\_\_\_

Sprzedawca: \_\_\_\_\_

Adres sprzedawcy: \_\_\_\_\_

Strona web  
sprzedawcy: \_\_\_\_\_

E-mail sprzedawcy: \_\_\_\_\_

Telefon sprzedawcy: \_\_\_\_\_

Polski

### **Odwiedz nas na Facebook i Twitter!**



<https://www.facebook.com/Maxspect>



<http://twitter.com/maxspectled>

## Zawartość opakowania

**Proszę sprawdzić zawartość opakowania.**

### Części składowe

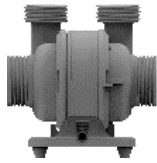

Pompa



Kontroler

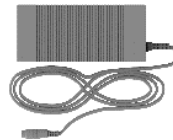

Zasilacz



kabel zasilający



Adapter zasilania awaryjnego

### Zapasowe części wlotu

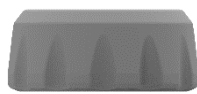

**1.**  $\Phi 58\text{mm}$  2pcs

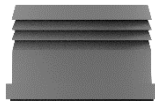

**2.** 1" 2pcs



**2A.**  $\Phi 32\text{mm}$  2pcs



**3.**  $\Phi 40\text{mm}$  2pcs



**4.** 2pcs

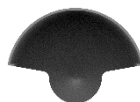

**5.** 2pcs

Polski

### Zapasowe części wylotu Duo

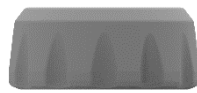

**6.**  $\Phi 51\text{mm}$  2pcs

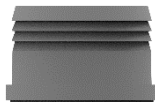

**7.**  $\frac{3}{4}$ " 2pcs

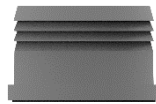

**7A.**  $\Phi 25\text{mm}$  2pcs



**7B.**  $\Phi 16\text{mm}/\frac{1}{2}$ " 2pcs  
 $\Phi 20\text{mm}/\frac{3}{4}$ " 2pcs



**7C.**  $\Phi 25\text{mm}/1$ " 2pcs  
 $\Phi 32\text{mm}/1\frac{1}{4}$ " 2pcs



**8.**  $\Phi 32\text{mm}$  2pcs

## Zawartość opakowania

### Zapaszowe części trójnika Y

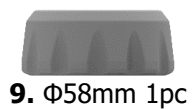

**9.**  $\Phi 58\text{mm}$  1pc



**10.** 1" 1pc



**10A.**  $\Phi 32\text{mm}$  1pc



**10B.**  $\Phi 25\text{mm}/1''$  1pc  
 $\Phi 32\text{mm}/1\frac{1}{4}''$  1pc



**11.**  $\Phi 40\text{mm}$  1pc



**12.** 1pc

### Zapaszowe części pojedynczego wylotu



**13.** 1pc



**14.** 1pc

## Środki ostrożności

Proszę o uważne przeczytanie poniższych instrukcji obsługi przed użyciem zestawu oświetleniowego DC pump Maxspect™ Turbine Duo. Proszę zwrócić szczególną uwagę na zawarte poniżej instrukcje.

Prosimy o przechowanie podręcznika do wykorzystania w przyszłości.

### PRZECZYTAJ I przestrzegaj WSZYSTKICH INSTRUKCJI BEZPIECZEŃSTWA

1. UWAGA – By uniknąć możliwości porażenia prądem należy postępować ostrożnie gdyż woda jest używana przez oprzyrządowanie akwarystyczne. W niżej wymienionych sytuacjach nie należy przystępować do naprawy samodzielnie, zwróć uszkodzony sprzęt do autoryzowanego serwisu bądź zutylizuj je.
  - a) Jeśli urządzenie wykazuje oznaki niespodziewanego przeciekania, natychmiast odłącz zasilanie.
  - b) Uważnie przyglądaj się urządzeniu po instalacji. Nie podłączaj urządzenia jeśli woda znajduje się na częściach które nie powinny być mokre.
  - c) Nie używaj urządzenia które: posiada uszkodzony kabel lub wtyczkę, nie funkcjonuje poprawnie, upadło lub zostało uszkodzone w jakikolwiek sposób.
  - d) By uniknąć zamoczenia wtyczki bądź gniazda elektrycznego, ustaw stelaż akwarium oraz samo akwarium po jednej stronie gniazda elektrycznego by uniknąć kapania na wtyczkę lub gniazdo. Pętla Drip Loop pokazana na obrazku powinna być układana z każdego kabla wychodzącego z urządzenia w akwarium podłączonego do gniazda. Pętla Drip loop to ta część kabla znajdująca się poniżej gniazda lub złącza jeśli przedłużacz jest używany. Jeśli wtyczka lub gniazdo zamoknie, NIE odłączaj kabla. Odłącz bezpiecznik lub wyłącznik nadprądowy który zasila urządzenie. Potem odłącz i zbadaj obecność wody w gniazdku.

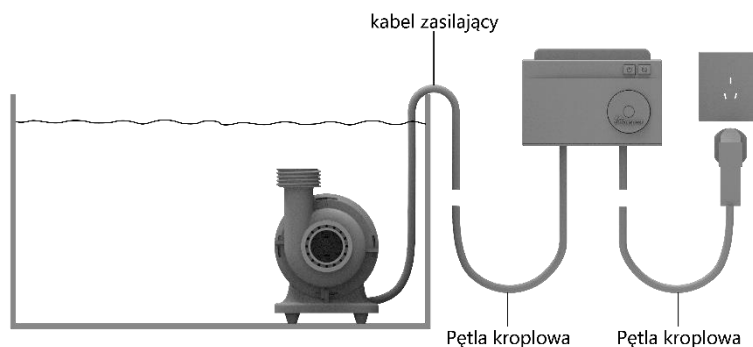

2. W przypadku używania urządzenia przez i przy dzieciach, zalecany jest szczególny nadzór.
3. By uniknąć zranienia, zaleca się unikanie kontaktu z częściami w ruchu bądź nagrzewającymi się takimi jak grzejniki, odbłyśniki, żarówki i tym podobne.
4. Zawsze odłączaj urządzenie jeśli nie jest używane, przed montażem i demontażem części oraz przed czyszczeniem. Nigdy nie szarp za kabel w celu wyciągnięcia wtyczki z gniazdka. Chwyć wtyczkę i pociągnij by rozłączyć.

## Środki ostrożności

5. Nie używaj urządzenia w innym celu niż przewidziany. Używanie dodatków nie polecanych bądź sprzedawanych przez producenta może stwarzać zagrożenie.
6. Nie instaluj bądź przechowuj urządzenia w miejscu wystawionym na warunki atmosferyczne bądź temperatury poniżej temperatury zamarzania.
7. Upewnij się że urządzenie jest zamontowane poprawnie i bezpiecznie w akwarium przed uruchomieniem.
8. Leia e observe todos os avisos importantes no aparelho.
9. Jeśli przedłużacz jest potrzebny, użyj przewodu z odpowiednimi parametrami. Przewód z niższym amperażem bądź mocą niż urządzenie może się przegrzać.
10. Kable zasilacza powinny być ułożone tak by nie zostały zdeptane bądź przyciśnięte przedmiotami ułożonymi na nich lub dociśniętymi do nich. Nigdy nie chwytaj wtyczki bądź kabla mokrymi rękami, zawsze chwytaj za obudowę wtyczki przy podłączaniu lub odłączaniu.
11. Urządzenie jest zaprojektowane TYLKO do użytku pod wodą, cały korpus urządzenia musi być zanurzony.

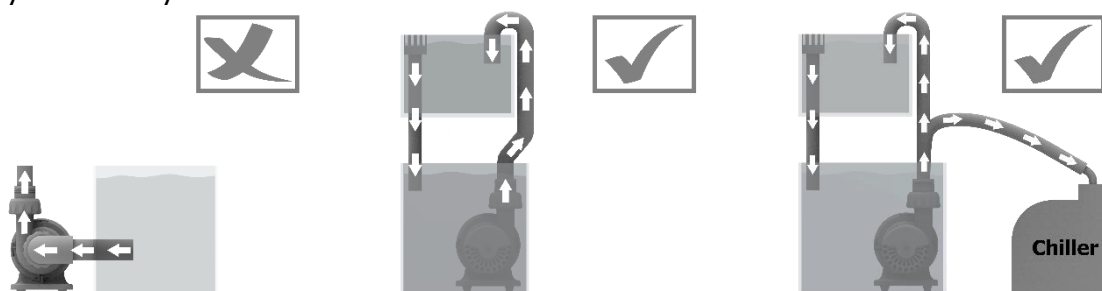

12. By utrzymać sprawność działania urządzenia, musi być zainstalowane w miejscu gdzie odległość wlotu od wylotu jest mniejsza niż 2m (6.5ft).

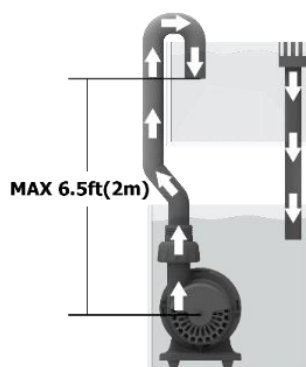

## Regularna konserwacja pompy

### Konserwacja urządzenia

Twoja Pompa Turbine Duo DC jest zaprojektowana by pracować optymalnie przy jak najmniejszej potrzebie uwagi po wstępnym montażu. Jednakże, przez ciężkie warunki pracy w morskim akwarium i wynikającym naroście alg i organiki, zaleca się czyszczenie pompy by zapewnić długotrwałe działanie urządzenia. Maxspect zaleca czyścić urządzenie co 6 miesięcy lub tak często jak tego wymaga. By przystąpić do czyszczenia należy otworzyć osłonę wirnika i delikatnie wyszorować wirnik i wnętrze osłony miękką szczotką pod bieżącą wodą. Jeśli wystąpiły naroście wapienne może to wymagać zamoczenia tych części w słabym roztworze kwasu jak np.: ocet spirytusowy. Nie używaj silnych kwasów, może to uszkodzić części. Po wyczyszczeniu, złóż urządzenie z powrotem.

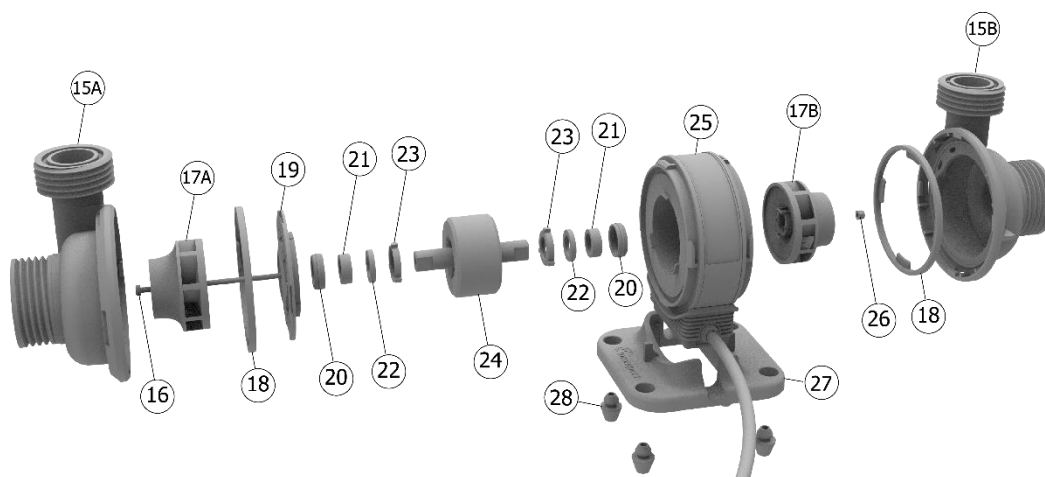

- |                          |                          |                          |                          |
|--------------------------|--------------------------|--------------------------|--------------------------|
| 15A. Obudowa wirnika (A) | 15B. Obudowa wirnika (B) | 16. Śruba                | 17A. Wirnik(A)           |
| 17B. Wirnik(B)           | 18. Uszczelka silikonowa | 19. Osłona wirnika       | 20. Silikonowa podkładka |
| 21. Łożysko              | 22. Ceramiczne łożysko   | 23. Silikonowa podkładka | 24. Rotor                |
| 25. Stator               | 26. Nakrętka             | 27. Podstawa pompy       | 28. Silikonowa podkładka |

## Instalacja wlotu

Możesz zamieniać gwint przyłącza pomiędzy 2/2A by dopasować inny rozmiar rury podczas gdy Turbine Duo pracuje jako pompa zamkniętego obiegu.

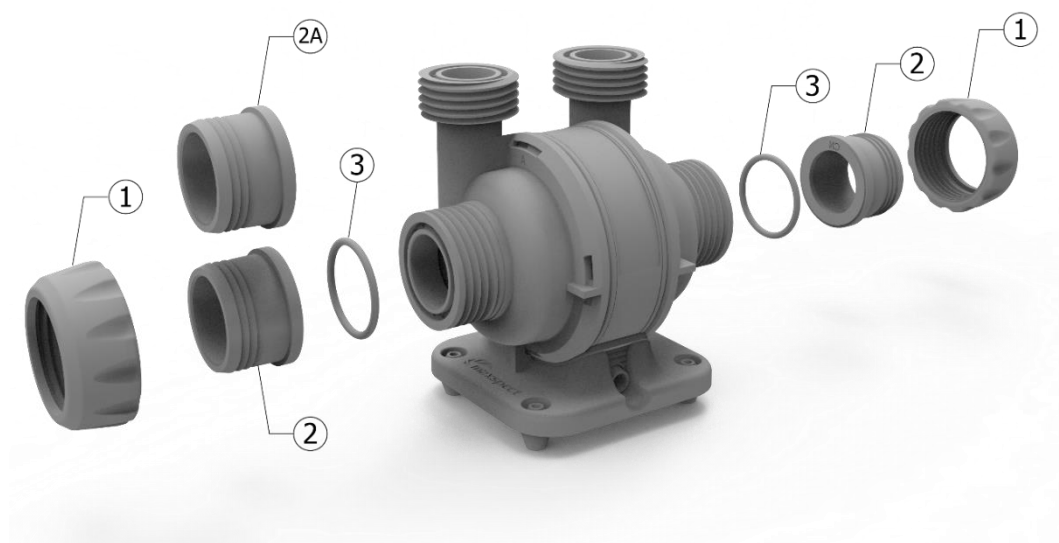

Lub można też zainstalować dwie sieci wlotowe podczas pracy jako pompa zwrotna.

Polski

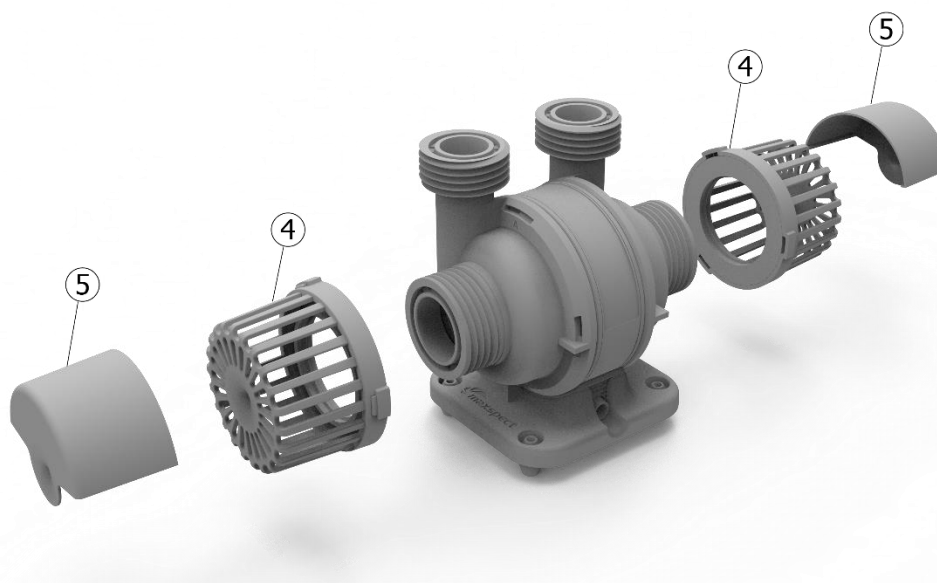



## Instalacja wylotu

**Wyloty Duo:** Zamieniaj gwinty uniwersalne pomiędzy 7 / 7A / 7B / 7C na rurę o różnej wielkości lub wąż.

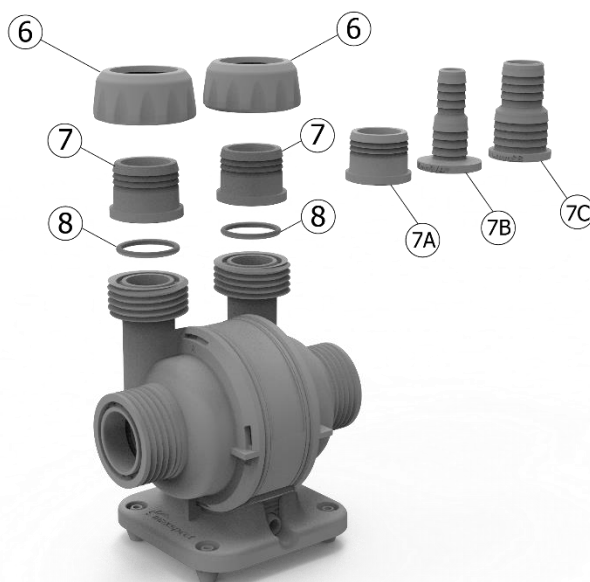

**Łączone wyloty z użyciem trójnika Y:** Przełącz gwinty pomiędzy 10 / 10A / 10B na rurę o różnej średnicy lub wąż.

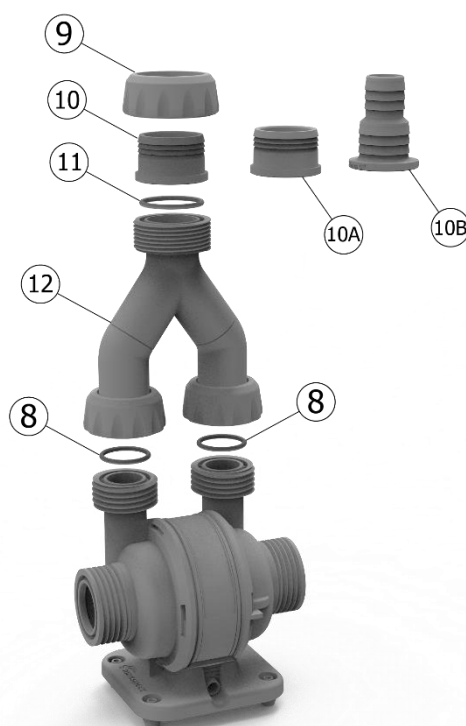

**Pojedynczy wylot:** Można również wymienić obudowę wirnika B na zaślepkę, aby uzyskać pojedynczą pompę prądu stałego.

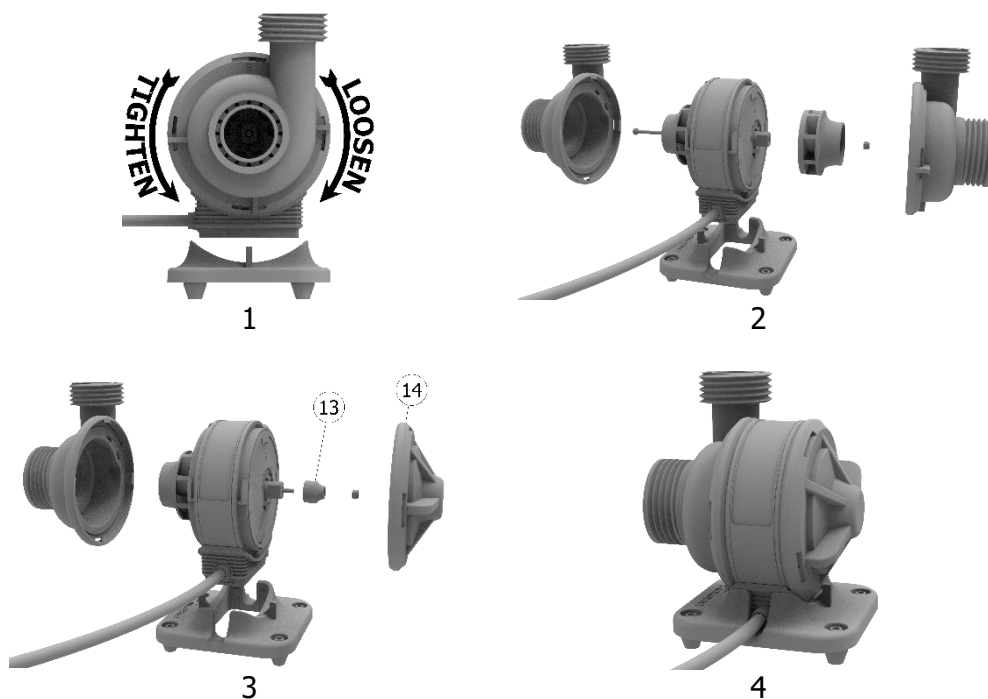

**Uwaga: Tylko wirnik B może być wymieniony na zaślepkę. Podstawa pompy musi być założona przed uruchomieniem.**

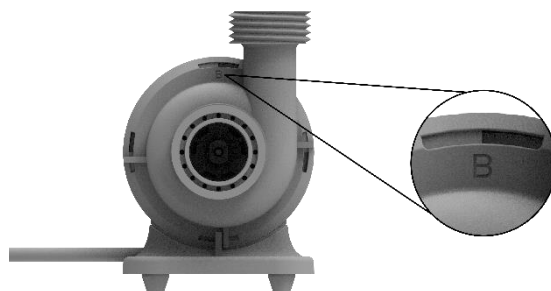

Polski

## Kierunek wylotu

Obydwie obudowy wirnika A i B mogą być zainstalowane w 3 kierunkach.



## Instrukcje obsługi

### Kontroler Turbine Duo

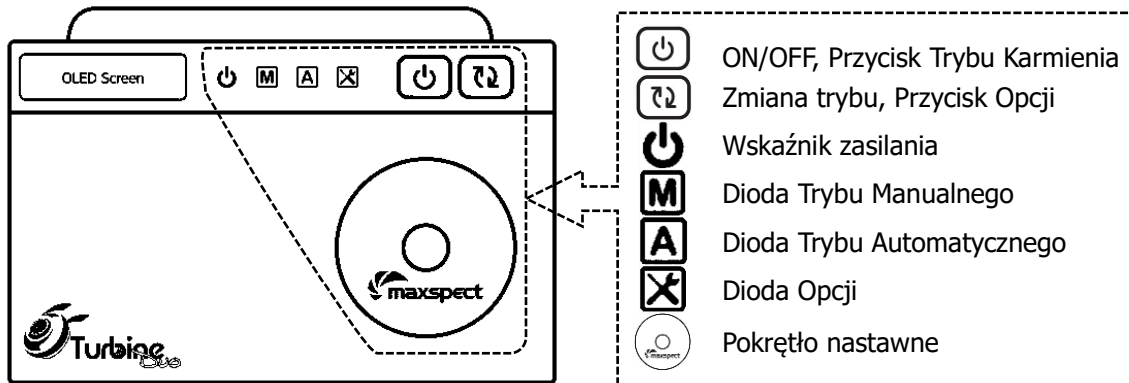

### Przełącznik ON/OFF Turbine Duo

Naciśnij i przytrzymaj przycisk ON/OFF przez 4s by włączyć lub wyłączyć urządzenie, pompa się zatrzyma a diody i wyświetlacz OLED kontrolera zgasną. Lecz jeśli urządzenie jest połączone z ICV6 (sprzedawane oddzielnie) nadal może być włączone przez aplikację Syna-G.

### Inicjalizacja Twojej Turbine Duo

Przed użyciem urządzenia jest parę podstawowych ustawień które musisz wykonać.

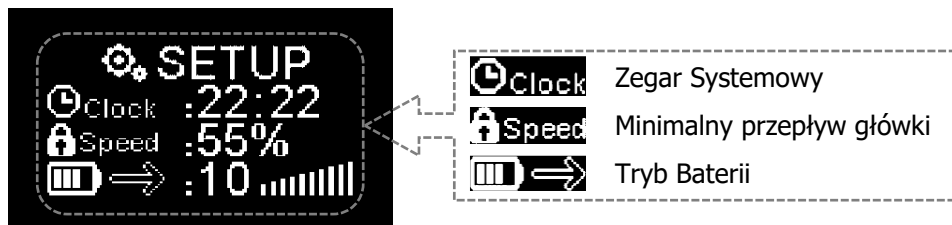

**Zegar:** Ustaw czas systemowy by zgadzał się z twoim czasem lokalnym.



**Prędkość:** Ustaw minimalny stały przepływ pompy. Oznacza to, że ustawienie minimalnego przepływu wody we wszystkich trybach przepływu wody będzie obliczane na podstawie tej wartości. Regulowany minimalny zakres wynosi od 1% do 90%.

**Tryb Baterii:** Ustaw prędkość pracy pompy w czasie kiedy jest zasilana z baterii awaryjnej. Urządzenie jest pakowane z adapterem zasilania awaryjnego z dwoma gniazdami kabla zasilającego, jeden służy do podpięcia zasilania z zasilacza oferowanego przez Maxspect, a drugi do podłączenia baterii DC12v (sprzedawana oddzielnie). Kiedy prąd z zasilacza zostaje odcięty, źródło zasilania zostanie przełączone automatycznie na baterię.



## Instrukcje obsługi

1. Kiedy ekran OLED jest aktywny, naciśnij przyciski

 i  naraz by wejść w tryb ustawień.

2. Naciśnij  by przełączać między ustawieniami.

3. Przekręć  by ustawić wartość.

4. Naciśnij  by zapisać ustawienie.



### Przełączanie pomiędzy trybami Automatycznym i Manualnym

**Tryb Manualny:** Ręcznie ustaw tryb ruchu wody i poziom przepływu w swoim Turbine Duo.

**Tryb Automatyczny:** Zestaw programów z nastawnymi trybami ruchu wody i poziomu przepływu który będzie powtarzany co 24h.

Interfejs trybu Manualnego

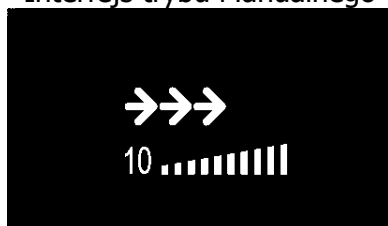

Interfejs trybu Automatycznego

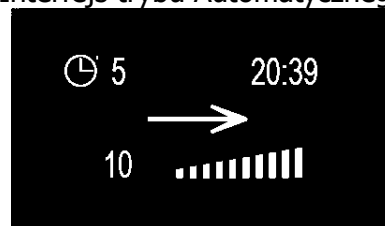



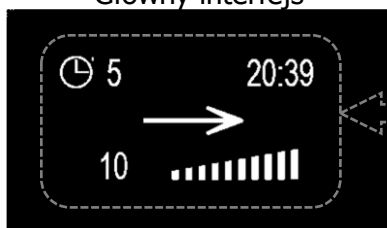

### Wprowadzenie do Interfejsu

Polski



Główny interfejs

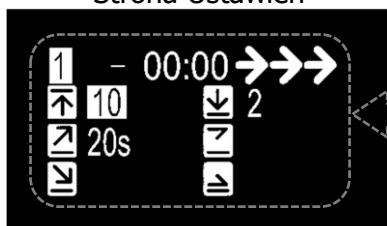

-  **5** Bieżący punkt czasowy
-  **20:39** Aktualny Czas
-  Tryb Ruchu Wody
-  **10** Poziom Przepływu
-  Indykator Poziomu

Strona Ustawień



-  **1** - **00:00** Punkt czasowy(całkowity 24)
-  Tryb Ruchu Wody
-  **10** **20s** **2** Zmienne konfigurowalne

# Instrukcje obsługi

## Wyświetlacz ikon OLED

### Tryby falowania



Tryb ręczny



Tryb pulsacyjny



Tryb losowy



Zaawansowany Tryb Pulsowania

### Variables



Maksymalny przepływ



Czas przyspieszania



Maksymalny czas przepływu



Minimalny przepływ



Czas hamowania



Minimalny czas przepływu

### Ilustracja zmiennych

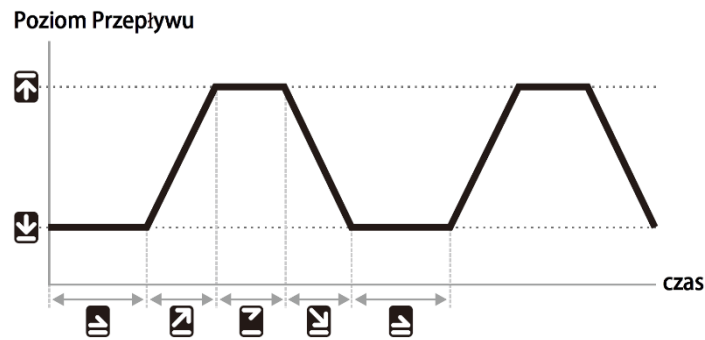

### Ilustracja trybu przepływu wody



Tryb ręczny

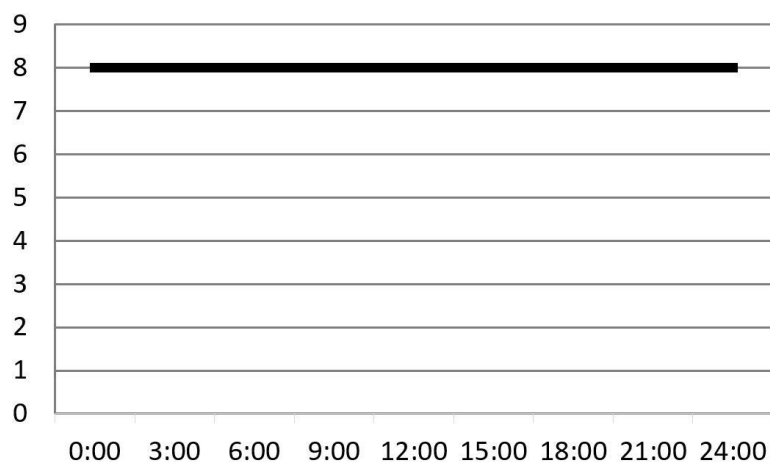

### Zmienne konfigurowalne

Zakres przepływu: 1-10



Poziom 8



N/A



N/A



N/A



N/A



N/A

## →→→ Tryb pulsacyjny

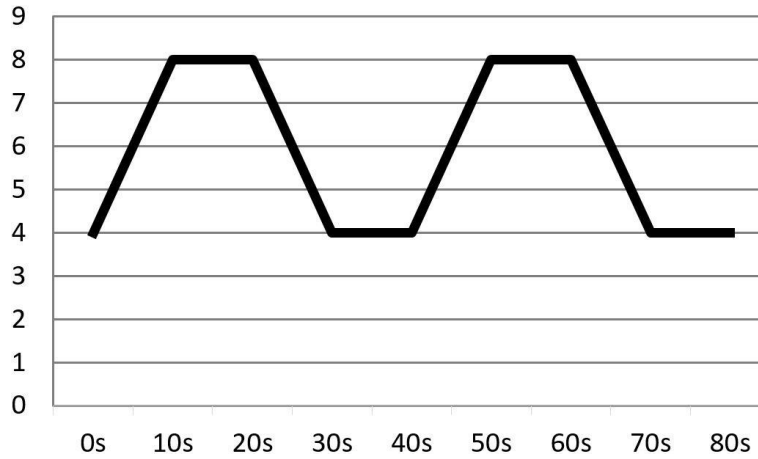

### Zmienne konfigurowalne

Zakres przepływu: 1-10

Zakres czasu: 2-30s



Poziom 8



10s



N/A



Poziom 4



N/A



N/A



= = = = 10s

## →→→ Tryb losowy

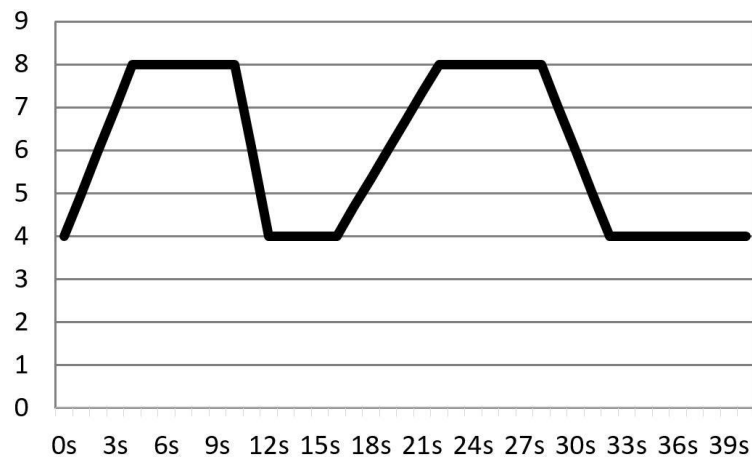

### Zmienne konfigurowalne

Maks Zakres przepływu: 2-10, Min Zakres przepływu: 1-9



Poziom 8



N/A



N/A



Poziom 4



N/A



N/A

# Instrukcje obsługi



## Zaawansowany Tryb Pulsowania

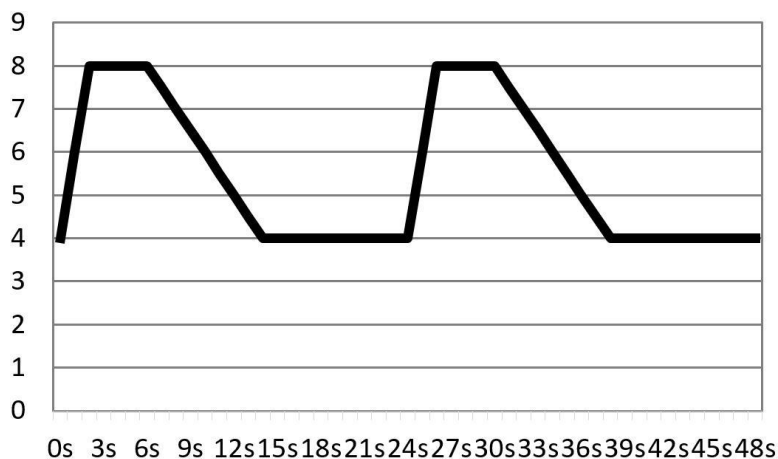

### Zmienne konfigurowalne

Zakres przepływu: 1-10

Zakres czasu: 2s-5m



Poziom 8



2s



4s



Poziom 4



8s



20s

### Tryb ręczny

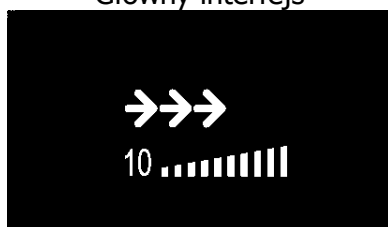

Główny interfejs

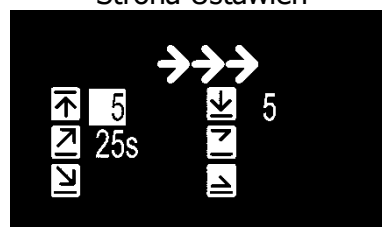

Strona Ustawień





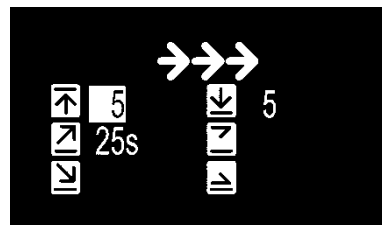

Polski

1. Naciśnij  by przełączyć między ustawieniami.
2. Przekręć  by ustawić wartość.
3. Naciśnij  by zapisać ustawienie.

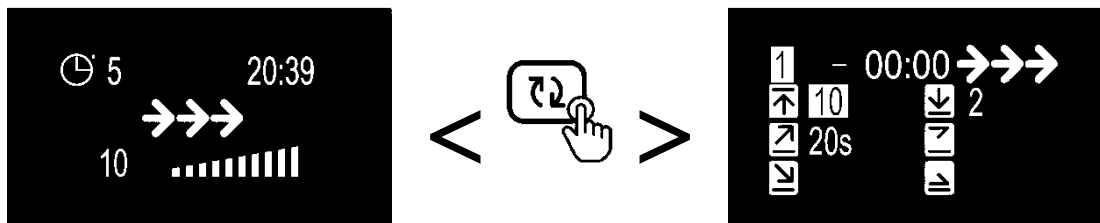

## trybu Automatycznego



1. Naciśnij  by przełączać między ustawieniami.
2. Przekręć  by ustawić wartość.
3. Naciśnij  by zapisać ustawienie.

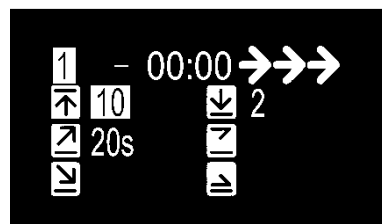



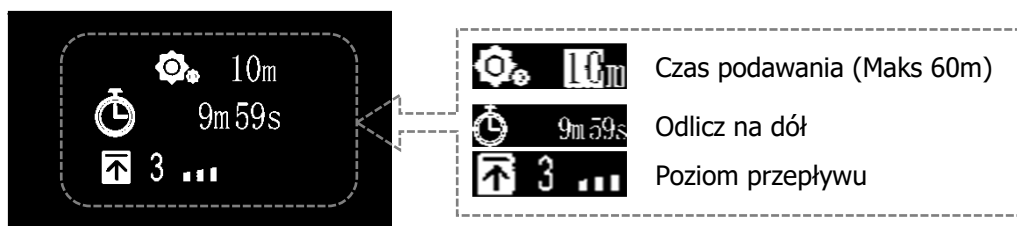

## Tryb karmienia



Polski

W głównym interfejsie naciśnij  by wejść w tryb Karmienia.

1. Naciśnij  by włączyć ustawienie.
2. Naciśnij  by przełączać między ustawieniami.
3. Przekręć  by ustawić wartość.
4. Naciśnij  by zapisać ustawienie.

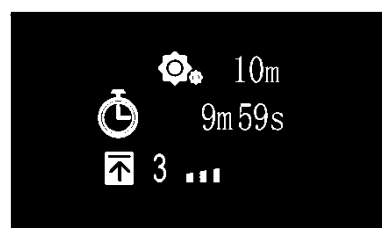



# Instrukcje Konserwacja

## Ustawienia Systemowe

Ustawienia Systemowe zawierają zestaw funkcji pozwalających użytkownikowi przeprowadzić konserwację lampy.

By wejść w stronę Ustawień Systemowych, najpierw wyłącz lampę, następnie naciśnij i przytrzymaj pokrętko nastawne jednocześnie włączając lampę ponownie. Przytrzymuj pokrętko nastawne aż strona Ustawień Systemowych wyświetli się na ekranie OLED.

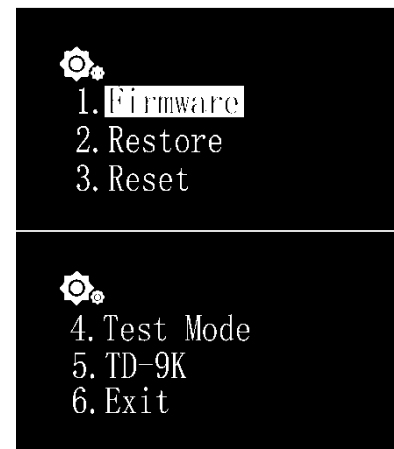

W Ustawieniach Systemowych jest 5 opcji.

1. Firmware
2. Restore(Przywracanie)
3. Reset
4. Test Mode(Tryb testowy)
5. Numer Modelu
6. Exit(Wyjście)



### 1. Firmware

Ta funkcja pozwala użytkownikowi dokonać aktualizacji firmware.

1. Obracać się  wybrać "Firmware".
2. naciśnij  by rozpocząć aktualizację firmware.

1. Jeśli nie ma karty SD albo jest na niej nieprawidłowy plik firmware, informacja „Brak karty SD” lub „Zły plik” zostanie wyświetlona.
2. W każdym innym przypadku postęp aktualizacji będzie wyświetlany.

Kiedy proces aktualizacji zakończy się pomyślnie, lampa zostanie uruchomiona ponownie a numer wersji nowego firmware zostanie wyświetlony.

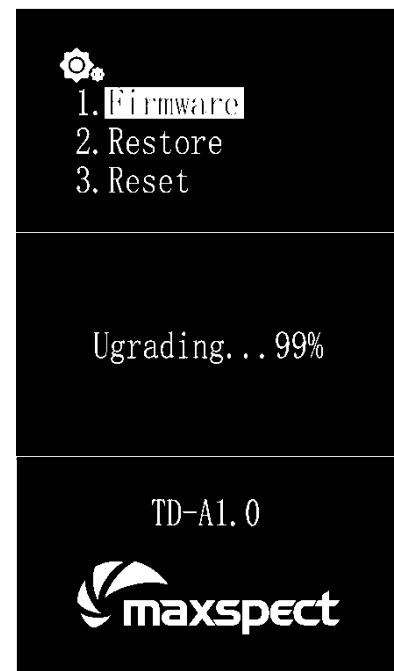

Polski

## Instrukcje Konserwacja

### 2. Restore(Przywracanie)



Ta funkcja pozwala użytkownikowi przywrócić oryginalne firmware lampy. Po przywróceniu firmware do oryginalnego stanu, lampa zostanie uruchomiona ponownie a numer firmware zostanie wyświetlony.

1. Obracać się  wybrać "Restore".
2. naciśnij  by przywrócić firmware.



### 3. Reset

Ta funkcja pozwala użytkownikowi przywrócić ustawienia fabryczne lampy. Po przywróceniu ustawień, lampa uruchomi się ponownie.

1. Obracać się  wybrać "Reset".
2. naciśnij  by przywrócić ustawienia fabryczne.





### 4. Test Mode(Tryb testowy)

Ta funkcja pozwala użytkownikowi ustawić lampę w tryb testowy, co pomoże naszemu przedstawicielowi obsługi klienta zdiagnozować lampę. **To powinno być dokonywane tylko za poleceniem autoryzowanego dealera lub przedstawiciela obsługi klienta by przeprowadzać pewne testy na urządzeniu.**

### 5. Numer Modelu

Ta funkcja wyświetla numer modelu lampy, który także jest nazwą ID gdy Turbine Duo jest połączony z urządzeniem iOS lub Android przez system Syna-G. **W normalnych okolicznościach nie należy modyfikować tej wartości.**

### 6. Exit(Wyjście)

1. Obracać się  wybrać "Exit".
2. naciśnij  do ponownego uruchomienia urządzenia.

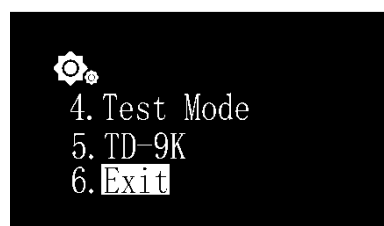

## Gwarancja

Pompa prądu stałego Maxspect™ Turbine Duo pokryte są 12 miesięczną gwarancją, która obejmuje wady produkcji.

Jeżeli wada produkcji pojawi się w okresie gwarancji, Maxspect Ltd. zastrzega sobie prawo naprawy (przy użyciu zarówno części nowych jak i regenerowanych) bądź wymiany (na produkt nowy bądź regenerowany) produktu wadliwego, bez dodatkowych kosztów.

Gwarancja nie obejmuje urządzeń uszkodzonych na skutek niewłaściwego użytkowania, modyfikacji, upadków, nie autoryzowanych prób naprawy.

### WYŁĄCZENIE ZA SZKODY WTÓRNE I PRZYPADKOWE:

Użytkownik urządzeń Maxspect nie ma prawa roszczyć żądań odszkodowania za szkody pośrednie i bezpośrednie, bez jakichkolwiek ograniczeń, wynikające z: osobistych niedogodności, uszkodzenia mienia osobistego, urządzeń telefonicznych, strat materialnych, itp. Niniejsza gwarancja obejmuje określone prawa konsumenta.

MAXSPECT LTD. NIE GWARANTUJE, A JEDNOCZESNIE NIE DEKLARUJE, POŚREDNIO I BEZPOSREDNIO, W ODNIESIENIU DO JAKOŚCI PRODUKTÓW: WYDAJNOŚCI PRODUKTU, PRZYDATNOŚCI DO CELÓW INNYCH NIŻ WSKAZANY. W REZULTACIE PRODUKT TEN, SPRZEDAWANY W OBECNEJ POSTACI, PODDANY JEST CAŁKOWITEMU RYZYKU NABYWCY ZWIĄZANEMU Z JEGO JAKOŚCIĄ I WYDAJNOŚCIĄ.

W ŻADNYM WYPADKU MAXSPECT LTD. NIE MOŻE ZOSTAĆ POCIĄGNIĘTY DO ODPOWIEDZIALNOŚCI ZA SZKODY POŚREDNIE I BEZPOŚREDNIE, SPECYFICZNE I WYPADKOWE, WYNIKAJĄCE Z JAKIEGOKOLWIEK PROBLEMU ZWIĄZANEGO Z PRODUKTEM BĄDŹ JEGO DOKUMENTACJĄ.

Gwarancja oraz wyżej wymienione zasady zastępują wszelkie inne, wyrażone ustnie i pisemnie, wyraźnie bądź w sposób domniemany. W żadnym wypadku sprzedawca, agent, pracownik, itp, nie jest uprawniony do naniesienia jakichkolwiek poprawek, modyfikacji, poszerzeń i dodatków do niniejszej gwarancji.

Nie wszystkie kraje przewidują wyłączenie bądź ograniczenie odpowiedzialności za szkody wypadkowe i wtórne, w związku z czym niniejsze zasady gwarancji mogą nie mieć zastosowania w Państwa wypadku.

### Uwaga

Najnowsze informacje dotyczące pompy DC Turbine Duo, Proszę odwiedź:  
[www.maxspect.com](http://www.maxspect.com)



**亲爱的客户,**

多谢您选购我司商品。

为确保您的安全及使用本产品时得到最佳的效果，请仔细阅读此使用手册。

**用户资料:**

购买日期:

---

经销商名称:

---

经销商地址:

---

---

经销商网页:

---

经销商电邮:

---

经销商电话:

---

请检查包装内物件是否齐全。

主要部件

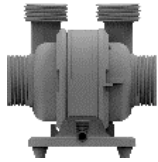

泵体



控制器

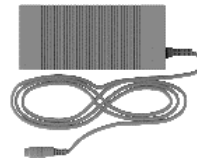

电源



电源线



备用电源转接线

进水口配件

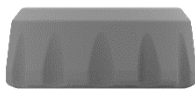

1.  $\Phi 58\text{mm}$  2 个

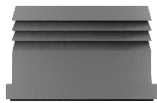

2. 1" 2 个

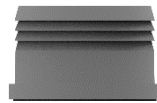

2A.  $\Phi 32\text{mm}$  2 个



3.  $\Phi 40\text{mm}$  2 个



4. 2 个



5. 2 个

双出水口配件

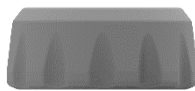

6.  $\Phi 51\text{mm}$  2 个

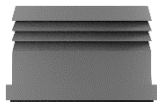

7.  $\frac{3}{4}$ " 2 个

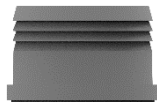

7A.  $\Phi 25\text{mm}$  2 个



7B.  $\Phi 16\text{mm}/\frac{1}{2}$ " 2 个  
 $\Phi 20\text{mm}/\frac{3}{4}$ " 2 个



7C.  $\Phi 25\text{mm}/1$ " 2 个  
 $\Phi 32\text{mm}/1\frac{1}{4}$ " 2 个



8.  $\Phi 32\text{mm}$  2 个

二合一出水口配件

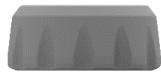

9.  $\Phi 58\text{mm}$  1 个



10. 1" 1 个



10A.  $\Phi 32\text{mm}$  1 个

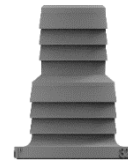

10B.  $\Phi 25\text{mm}/1''$  1 个  
 $\Phi 32\text{mm}/1\frac{1}{4}''$  1 个



11.  $\Phi 40\text{mm}$  1 个

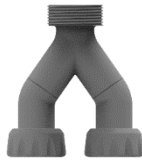

12. 1 个

单出水口配件



13. 1 个



14. 1 个

请在操作前，仔细阅读本操作说明，并特别注意遵照下列安全建议。

请保留本说明书以便日後查阅。

## 阅读并遵照以下所有安全说明

1. 危险-为避免可能触电，在装有水的鱼缸内操作设备请格外小心。出现以下任一情况时，不要尝试自行维修，请交由授权服务提供商处理。
  - a) 如果设备出现任何不正常漏水的情况，请立即断开电源。
  - b) 安装后请仔细检查设备，如果设备中不应有水的部位被沾湿，请不要将设备接通电源。
  - c) 如果设备的电源线或插头受损，或因为误操作、跌落而造成损坏，请不要继续使用设备。
  - d) 为避免设备的插头或插座被水沾湿，应将鱼缸放置在墙上装有插座的旁边。并且所有从鱼缸连接至插座的电源线的最低位应该低于插座的高度。如果插座不慎被水沾湿，不要直接拔出插头，应先断开插座所在电路的电源或拔出保险丝，然后再拔出插头清理积水。

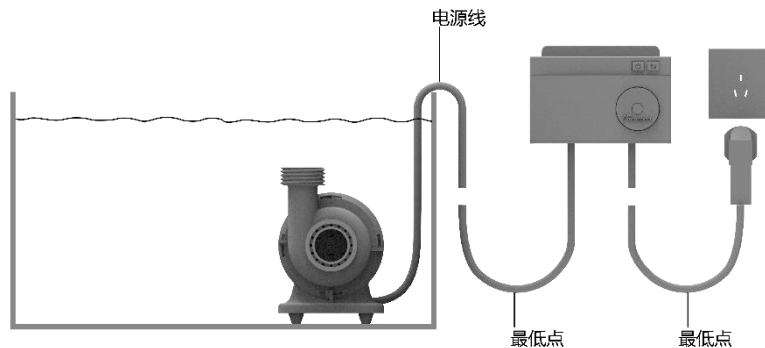

2. 如果使用中的设备附近有儿童，或设备由儿童操作，请格外注意。
3. 为避免可能受伤，请不要触碰任何转动中的部件。
4. 以下情况须先拔出插头：不再使用、安装、拆除或清洁前，不要拉扯电源线，应抓紧插头将插头从插座中拔出。
5. 不要将设备用作其他用途。在设备上使用未经厂家出售或推荐的零件可能会导致不安全。
6. 不要将设备安装、放置在户外，或温度在零度以下的环境中。
7. 使用设备前请确保设备安装牢固。
8. 仔细阅读并遵守设备上的安全指引。
9. 如果必须使用电源线延长线，延长线的电流负载能力必须满足设备的需求。
10. 应适当放置电源线以避免被踩踏或被其他物品挤压。手被沾湿时不要插、拔电源线。



## 注意事项

11. 设备只能放置在水中使用，而且泵体必须完全浸没在水中。

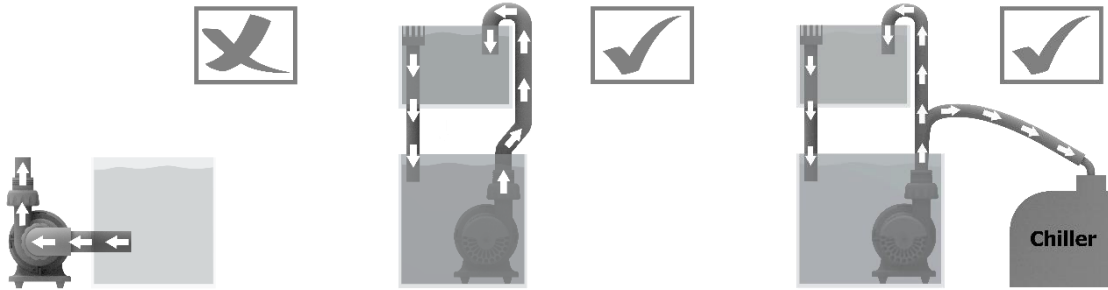

12. 为保持设备良好的运作性能，安装设备时出水口和入水口间的垂直距离不应大于 2 米。

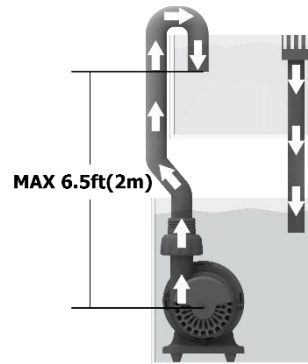

## 设备维护

设备一旦被安装使用后，一般情况下不需要过多关注便能良好地运作。然而，在海水鱼缸这样复杂的环境下，设备内部可能会生长出海藻或其他有机物。因此，我们建议用户每6个月、或在需要的情况下清洁设备以确保其使用寿命。清洁时，只需将泵体两侧拆开并放入流水中，用刷子清理泵体内部的积聚物。如果泵体内部积聚了碳酸钙，可用醋等弱酸将其清除，使用强酸可能会损坏设备。清洁后请重新安装设备。

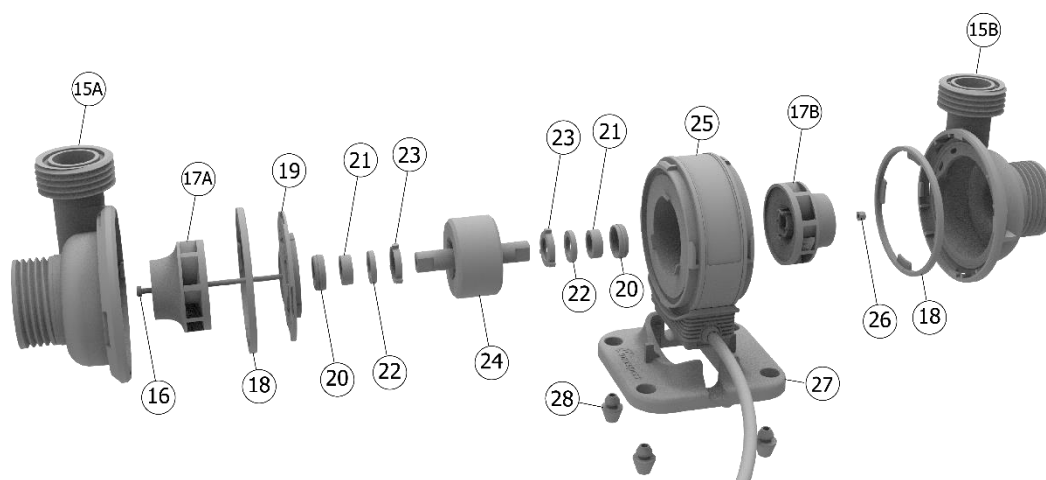

15A. 泵罩(A)

17B. 叶轮(B)

21. 轴承

25. 定子

15B. 泵罩(B)

18. 硅胶垫圈

22. 陶瓷轴承

26. 螺母

16. 螺丝

19. 转子盖

23. 硅胶座

27. 泵座

17A. 叶轮(A)

20. 硅胶座

24. 转子

28. 硅胶脚垫

## 进水口安装

当设备被用作循环泵时，可使用 2 或 2A 号接头匹配不同尺寸的水管。

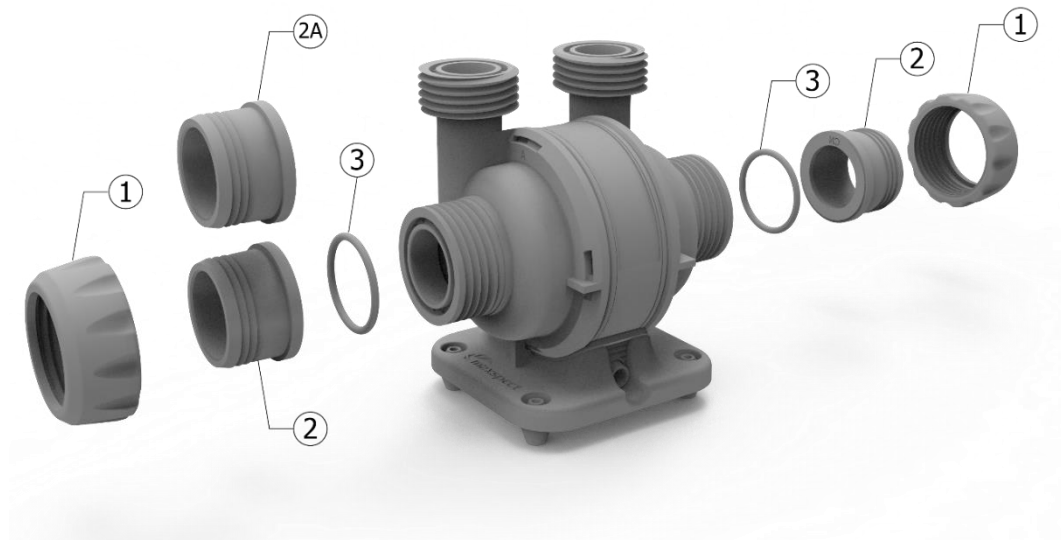

或当设备被用作上水泵时，进水口两侧可安装过滤罩以避免异物进入泵体。

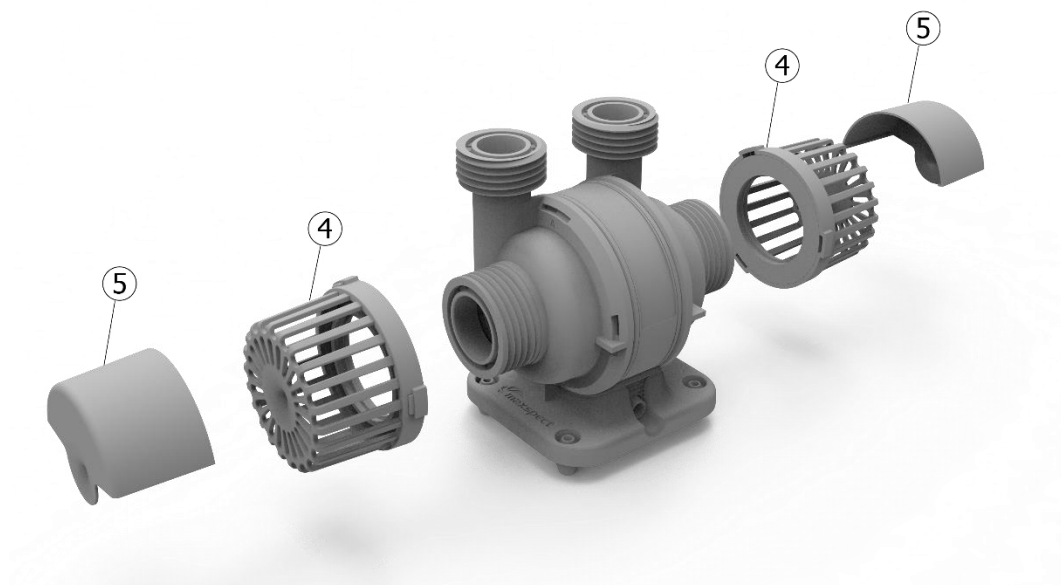

## 出水口安装

**双出水口：**可以使用 7、7A、7B 或 7C 号接头来匹配不同尺寸的软、硬水管。

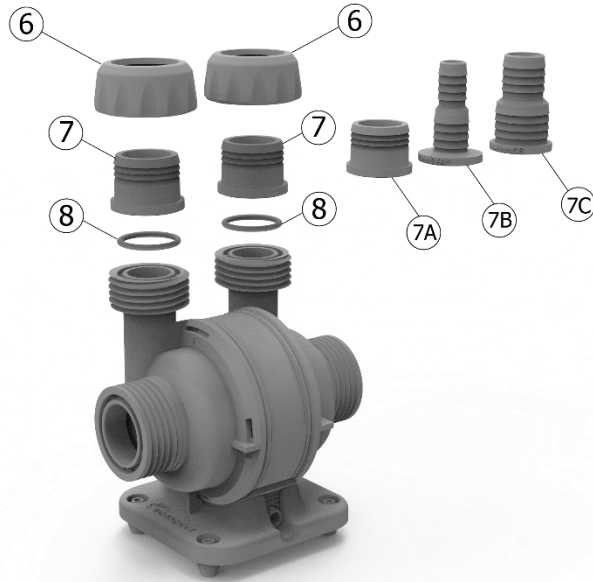

**二合一出水口：**可以使用 10、10A 或 10B 号接头来匹配不同尺寸的软、硬水管。

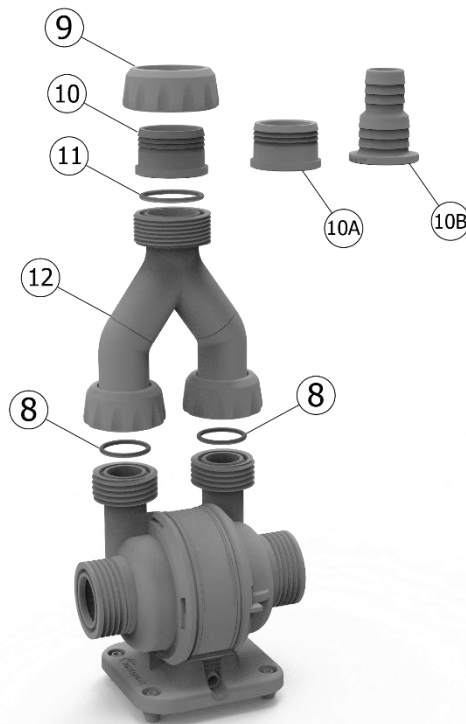

**单出水口：**可将泵体 B 侧罩体和叶轮拆除，更换为泵盖使之成为单出水口水泵。

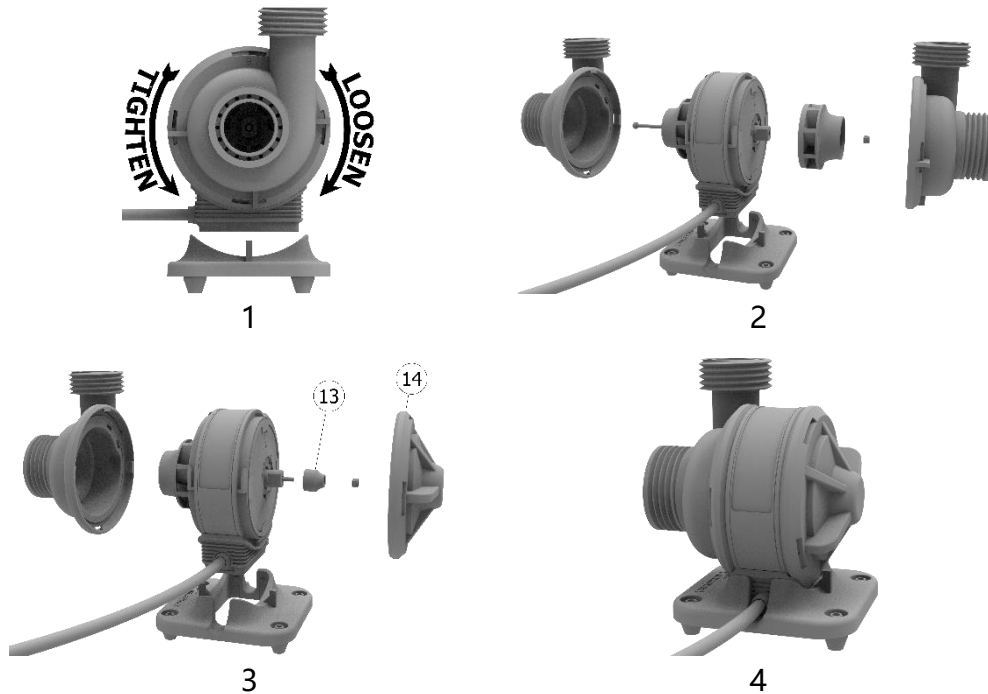

**提示：**只有 B 侧泵罩可以更换为泵盖；水泵运作前必须安装底座。

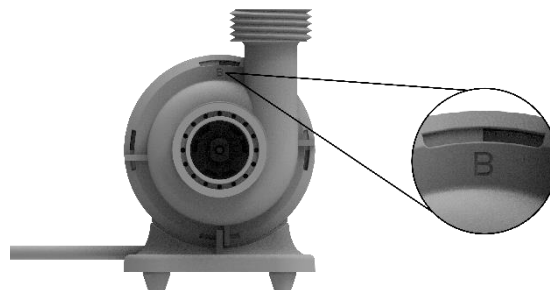

## 出水口方向

A 和 B 侧的出水口均有三个方向可以调节。



## 控制器

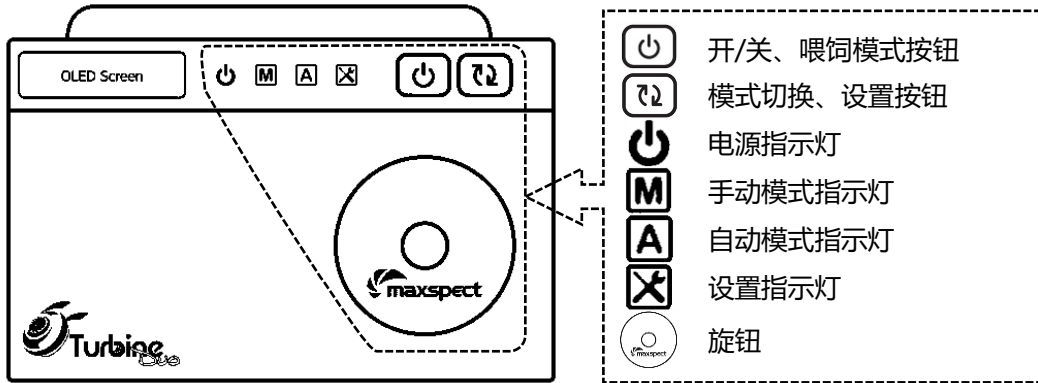

## 开、关设备

按住开关按钮超过 4 秒可以停止设备运行。当设备停止时，泵体停止运转，控制器显示屏和指示灯会熄灭。如果设备连接了 ICV6(另售)，可通过 Syna-G App 激活设备。

## 初始化设备

使用设备前，需要对设备进行初始化设置。

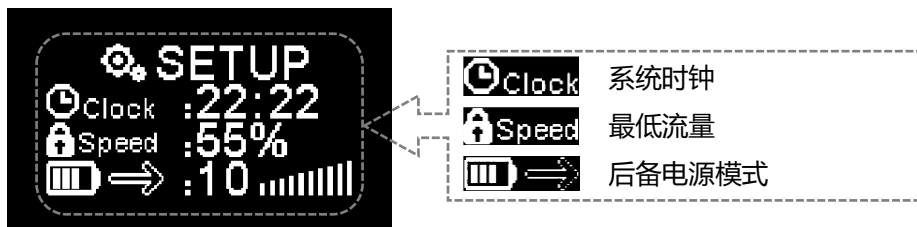



**系统时钟:**将系统时钟设置为用户当地的时间。

**最低流量:** 设置设备的最低流量。包括喂饲模式在内的所有水流模式，其可设置的最低流量均以此参数作为基础开始计算。最低流量的可设置范围是：1%-90%。

**后备电源模式:** 设置设备工作在后备电源模式下的流量。随设备附送的一条电源转换线，它有两个电源连接头，一头(DC24v)连接市电，一头(DC12v)连接后备电源(用户自行准备)，当市电被切断时，电源转换线将自动切换至后备电源供电。



1. 当 OLED 屏在激活的情况下，同时按动  和  按钮

可进入设置界面。

2. 按动  按钮切换选项。

3. 旋转  设置参数。

4. 按动  按钮保存设置。



## 切换自动模式和手动模式

**手动模式:** 手动设置设备的水流模式和流量。

**自动模式:** 一组可以独立设置水流模式和流量，并能够 24 小时循环的设定。

手动模式主界面

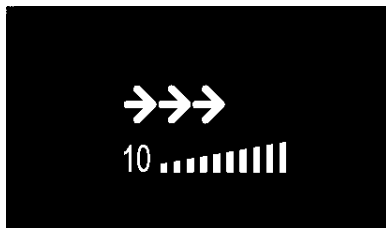

自动模式主界面

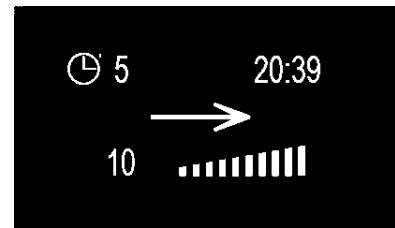

## 主界面功能介绍

主界面



-  5 当前时间点
-  20:39 当前时间
-  水流模式
-  10 流量
-  流量指示计

设置界面

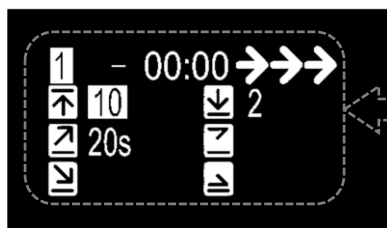

-  1 - 00:00 时间点(共 24 个)
-  水流模式
-  10 20s 2 参数变量

## OLED 显示屏图标说明

### 水流模式



恒速模式



随机模式



快慢模式



高级快慢模式

### 变量参数



最高流量



最低流量



上升时长



下降时长



最高流量持续时长



最低流量持续时长

### 变量参数说明

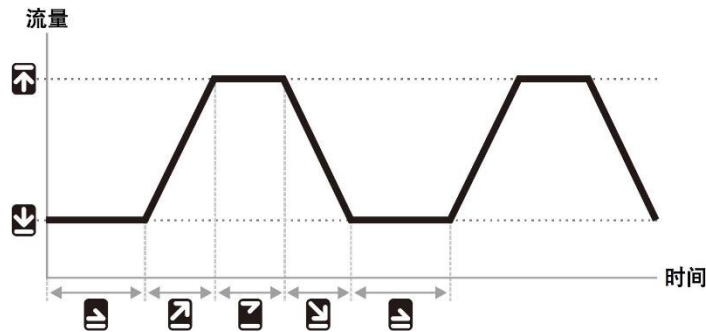

### 水流模式示例



恒速模式

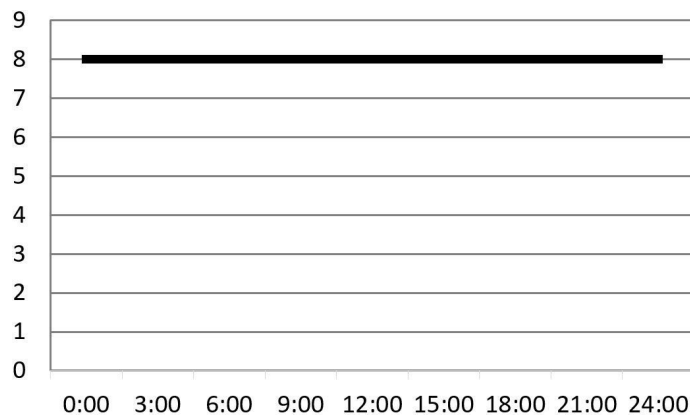

### 可设置参数

可设置流量范围: 1-10 档



8 档



N/A



N/A



N/A



N/A



N/A



**→→→ 快慢模式**

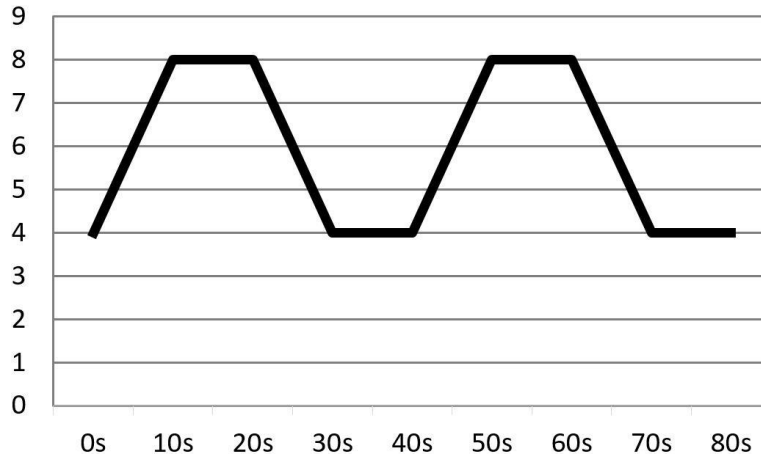

**可设置参数**

可设置流量范围: 1-10 档, 可设置时间范围: 2-30 秒

	8 档		10 秒		N/A			
	4 档		N/A		N/A			
	=		=		=		=	10 秒

**→→→ 随机模式**

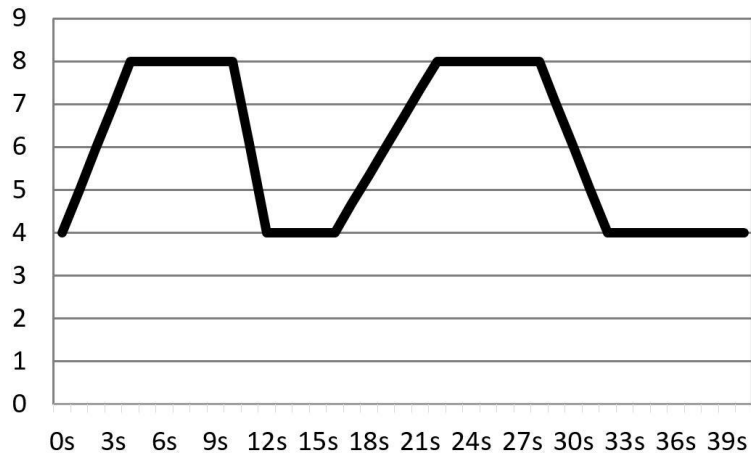

**可设置参数**

最大流量可设置范围: 2-10 档, 最小流量可设置范围: 1-9 档

	8 档		N/A		N/A
	4 档		N/A		N/A

**↔as** 高级快慢模式

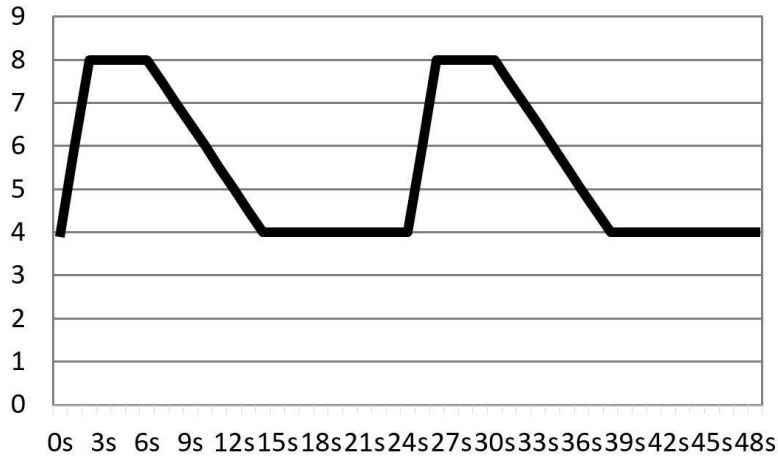

可设置参数

可设置流量范围: 1-10 档, 可设置时间范围: 2 秒-5 分钟

	8 档		2 秒		4 秒
	4 档		8 秒		20 秒

手动模式

主界面

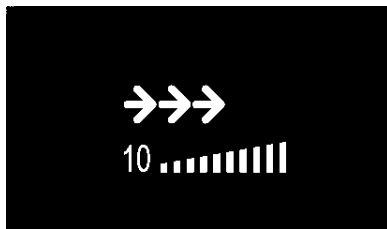

设置界面

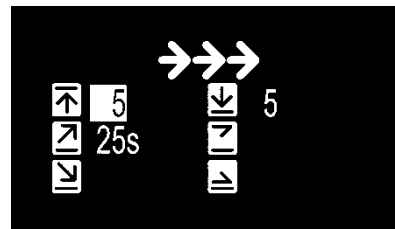

简中

1. 按动 切换选项。
2. 旋转 设置参数。
3. 按动 保存设置。

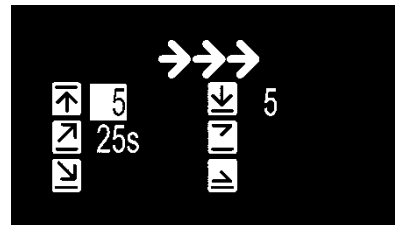

## 自动模式

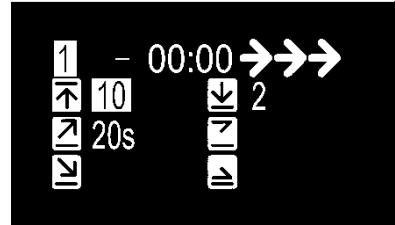
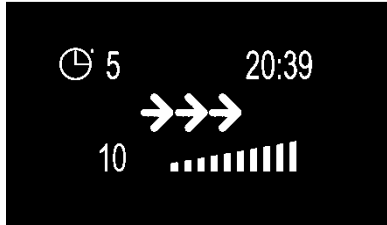

1. 按动  切换选项。
2. 旋转  设置参数。
3. 按动  保存设置。

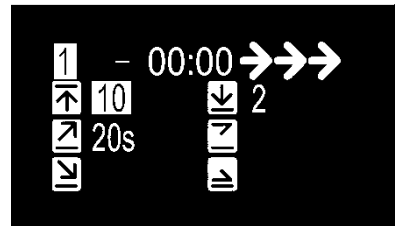

## 喂饲模式



在任一主界面下按动  进入喂饲模式。

1. 按动  激活设置界面。
2. 按动  切换选项。
3. 旋转  设置参数。
4. 按动  保存设置。

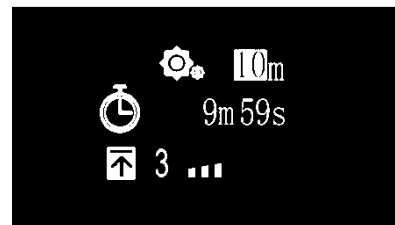

## 系统设定

系统设定包含一组基础功能供用户维护设备使用。

要进入系统设定界面，首先断开设备电源，按住旋钮，然后接通设备电源，直到屏幕显示系统设定界面便可松开旋钮。

系统设定包含 5 项功能：

1. 固件更新
2. 固件恢复
3. 恢复出厂设置
4. 系统测试
5. 型号选择
6. 退出

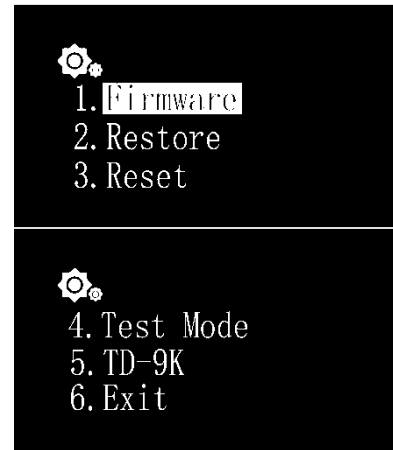

### 1. 固件更新

此功能用于更新系统固件。

1. 转动  选择 "Firmware"。
2. 按动  开始更新固件。

1. 当系统检测不到 micro SD card 或正确的固件文件时，屏幕会相应提示 "NO SD Card" 或 "Wrong File"。
2. 正常更新时屏幕会显示更新进度。

当固件成功更新后，系统会自动重启，新固件版本号会显示在启动界面中；更新固件不会影响用户设定。

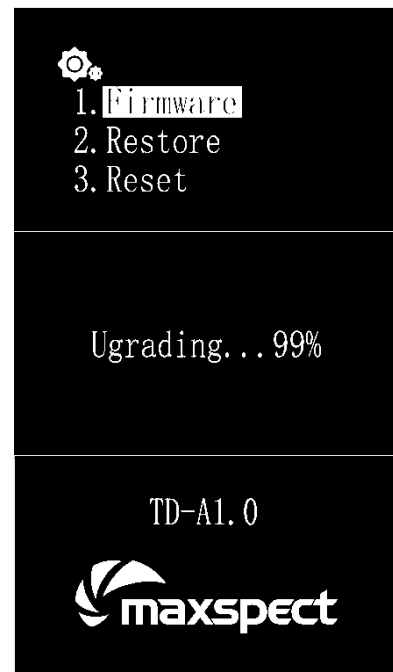

## 2. 固件恢复

此功能用于恢复出厂固件。当成功恢复后，系统会自动重启，版本号会显示在启动界面中，恢复出厂固件不会影响用户设定。

1. 转动  选择“Restore”。
2. 按动  开始恢复固件。



## 3. 恢复出厂设置

此功能用于恢复出厂设置。成功恢复后，系统会自动重启。

1. 转动  选择“Reset”。
2. 按动  恢复出厂设置。



## 4. 系统测试

此功能用于系统检测。**用户应在经销商或售后服务人员的指导或授意下执行系统检测操作。**

## 5. 型号选择

此功能用于设置设备型号，并且当设备和 Syna-G 系统连接时，作为设备名称使用。**正常情况下，用户不应更改此项设定。**

## 6. 退出

1. 转动  选择“Exit”。
2. 按动  退出系统设置。

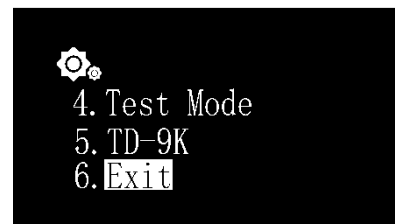

所有迈光品牌 (Maxspect) 产品自购买之日起 12 个月内若有质量问题, 可享有 Maxspect 公司的保修服务。若在保修期内出现质量问题, Maxspect 公司将免费维修或更换配件。

若产品由于误用, 被改装, 发生事故, 处理不当, 或使用不当而受到损坏, 或未经授权自行维修的, 则不在保修范围之内。不在保修范围的情况包括但不限于, 修改电路等被视为误用或滥用而损坏产品的行为。

### **间接及附带损害免责声明:**

Maxspect 对您或其他使用者的间接或附带损害不承担责任。间接或附带损害包括但不限于, 使用产品造成的损失或不便, 对个人财产造成的损失, 如电话, 收入损失或盈利损失。本质保书赋予您合法权利, 在不同的地区您还可能享有其它权利。

除上面明确提出的内容外, Maxspect 公司对产品的质量, 性能, 适销性或特别用途的适用性均没有作出明示或暗示的担保或陈述。因此, 本产品“按现状”提供, 您作为购买者承担有关此产品的质量和性能的全部风险。

在任何情况下, Maxspect 公司均不对因本产品或其文件的缺陷而引起的直接的、间接的、特别的、附带的或结果性的损害承担责任。

上述质保书, 声明和故障排除方法是唯一版本, 没有其它口头的或书面的, 明示的或暗示的内容。在任何时候, Maxspect 公司的经销商, 代理商或雇员都无权对此质保书进行更改、扩展或补充。

由于某些地区不允许此类附带性或结果性损害的免责或有限责任, 上述限制可能不适用于您。

**提示：**

关于产品规格等详细信息，请浏览 Maxspect 官方网站：[www.maxspect.com](http://www.maxspect.com)



## 親愛的客戶,

多謝您選購我司商品。

為確保您的安全及使用本產品時得到最佳的效果，請詳細閱讀此使用說明書。

### 用戶資料：

購買日期：

---

經銷商名稱：

---

經銷商地址：

---

---

經銷商網頁：

---

經銷商電郵：

---

經銷商電話：

---

請在 facebook 及 twitter 上關注我們!



<https://www.facebook.com/Maxspect>



<http://twitter.com/maxspectled>



請檢查包裝內物件是否齊全。

## 主要部件

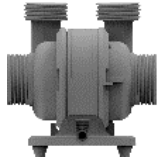

泵體



控制器

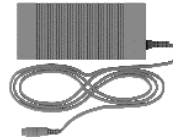

電源



電源線



後備電源轉接線

## 進水口配件

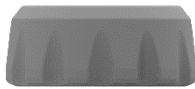

1.  $\Phi 58\text{mm}$  2 個

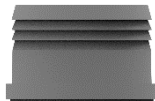

2. 1" 2 個

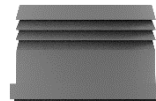

2A.  $\Phi 32\text{mm}$  2 個



3.  $\Phi 40\text{mm}$  2 個



4. 2 個



5. 2 個

## 雙出水口配件

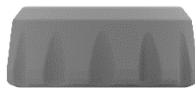

6.  $\Phi 51\text{mm}$  2 個

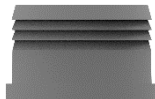

7.  $\frac{3}{4}$ " 2 個

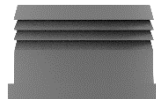

7A.  $\Phi 25\text{mm}$  2 個



7B.  $\Phi 16\text{mm}/\frac{1}{2}$ " 2 個  
 $\Phi 20\text{mm}/\frac{3}{4}$ " 2 個



7C.  $\Phi 25\text{mm}/1$ " 2 個  
 $\Phi 32\text{mm}/1\frac{1}{4}$ " 2 個



8.  $\Phi 32\text{mm}$  2 個

二合一出水口配件

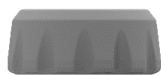

9.  $\Phi 58\text{mm}$  1 個

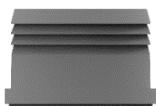

10. 1" 1 個

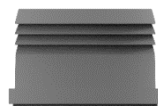

10A.  $\Phi 32\text{mm}$  1 個



10B.  $\Phi 25\text{mm}/1"$  1 個  
 $\Phi 32\text{mm}/1\frac{1}{4}"$  1 個



11.  $\Phi 40\text{mm}$  1 個



12. 1 個

單出水口配件



13. 1 個



14. 1 個

請在操作前，仔細閱讀本操作說明，並特別注意遵照下列安全建議。

請保留本說明書以便日後查閱。

### 閱讀並遵照以下所有安全指引

1. 危險-為避免可能觸電，在裝有水的魚缸內操作設備請格外小心。出現以下任一情況時，不要嘗試自行維修，請交由授權服務提供商處理。
  - a) 如果設備出現任何不正常漏水的情況，請立即斷開電源。
  - b) 安裝後請仔細檢查設備，如果設備中不應有水的部位被沾濕，請不要將設備接通電源。
  - c) 如果設備的電源線或插頭受損，或因為誤操作、跌落而造成損壞，請不要繼續使用設備。
  - d) 為避免設備的插頭或插座被水沾濕，應將魚缸放置在牆上裝有插座的旁邊。並且所有從魚缸連接至插座的電源線的最低位應該低於插座的高度。如果插座不慎被水沾濕，不要直接拔出插頭，應先斷開插座所在電路的電源或拔出保險絲，然後再拔出插頭清理積水。

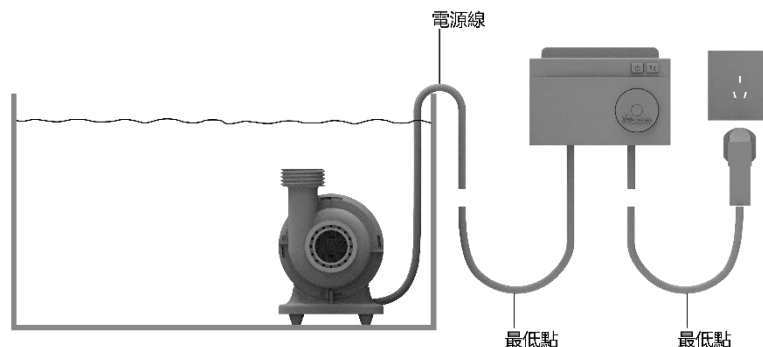

2. 如果使用中的設備附近有兒童，或設備由兒童操作，請格外注意。
3. 為避免可能受傷，請不要觸碰任何轉動中的部件。
4. 以下情況須先拔出插頭：不再使用、安裝、拆除或清潔前，不要拉扯電源線，應抓緊插頭將插頭從插座中拔出。
5. 不要將設備用作其他用途。在設備上使用未經本生產商出售或推薦的零件可能會導致不安全。
6. 不要將設備安裝、放置在戶外，或溫度在零度以下的環境中。
7. 使用設備前請確保設備安裝牢固。
8. 仔細閱讀並遵守設備上的安全指引。
9. 如果必須使用電源線延長線，延長線的電流負載能力必須滿足設備的需求。
10. 應適當放置電源線以避免電源線被踩踏或被其他物品擠壓。手被沾濕時不要插、拔電源線。

11. 設備只能放置在水中使用，而且泵體必須完全浸沒在水中。

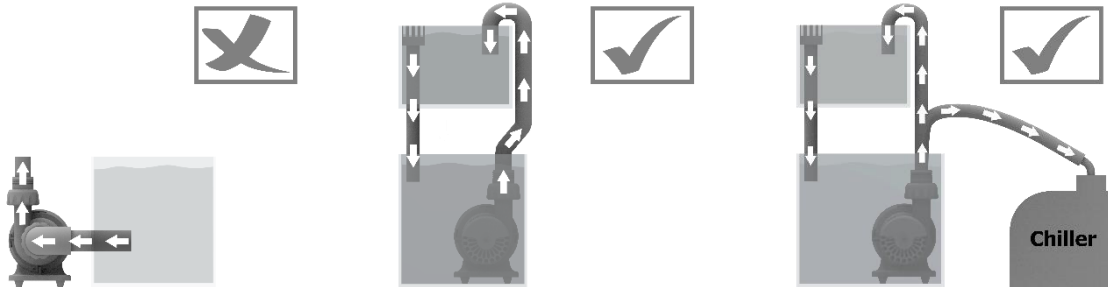

12. 為保持設備良好的運作性能，安裝設備時出水口和進水口間的垂直距離不應大於 6.5 英尺 (2 米)。

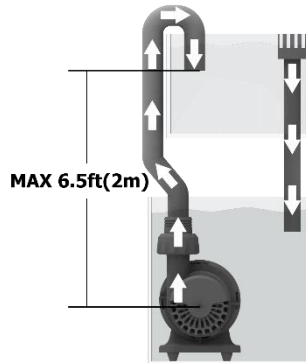

## 設備維護

設備一旦被安裝使用後，一般情況下不需要過多關注便能良好地運作。然而，在海水魚缸這樣複雜的環境下，設備內部可能會生長出海藻或其他有機物。因此，我們建議用戶每 6 個月、或在需要的情況下清潔設備以確保其使用壽命。清潔時，只需將泵體兩側拆開並放入流水中，用刷子清理泵體內部的積聚物。如果泵體內部積聚了碳酸鈣，可用醋等弱酸將其清除，使用強酸可能會損壞設備。清潔後請重新安裝設備。

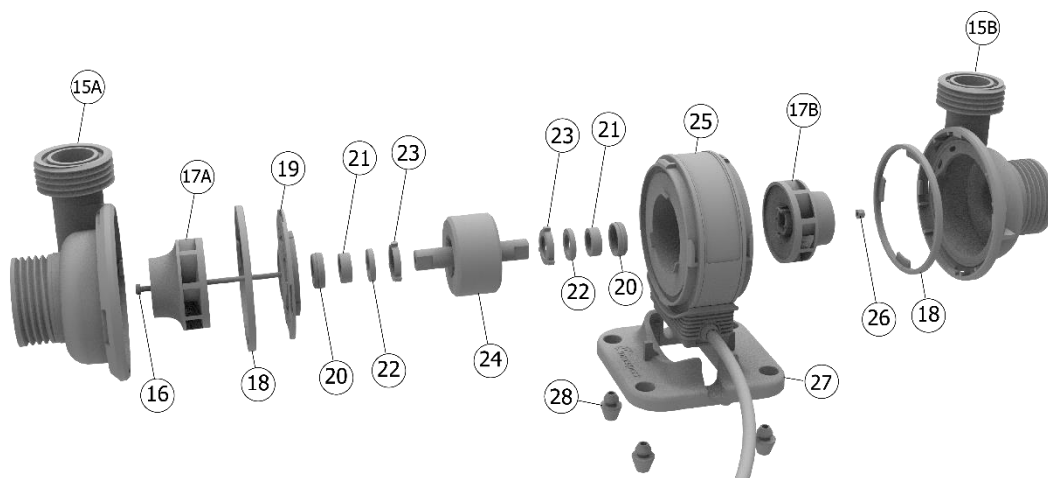

- |            |             |         |            |
|------------|-------------|---------|------------|
| 15A. 泵罩(A) | 15B. 泵罩 (B) | 16. 螺絲  | 17A. 葉輪(A) |
| 17B. 葉輪(B) | 18. 矽膠墊圈    | 19. 轉子蓋 | 20. 矽膠座    |
| 21. 軸承     | 22. 陶瓷軸承    | 23. 矽膠座 | 24. 轉子     |
| 25. 定子     | 26. 螺母      | 27. 底座  | 28. 矽膠腳墊   |

## 進水口安裝

當設備被用作循環泵時，可使用 2 或 2A 號接頭匹配不同尺寸的水管。

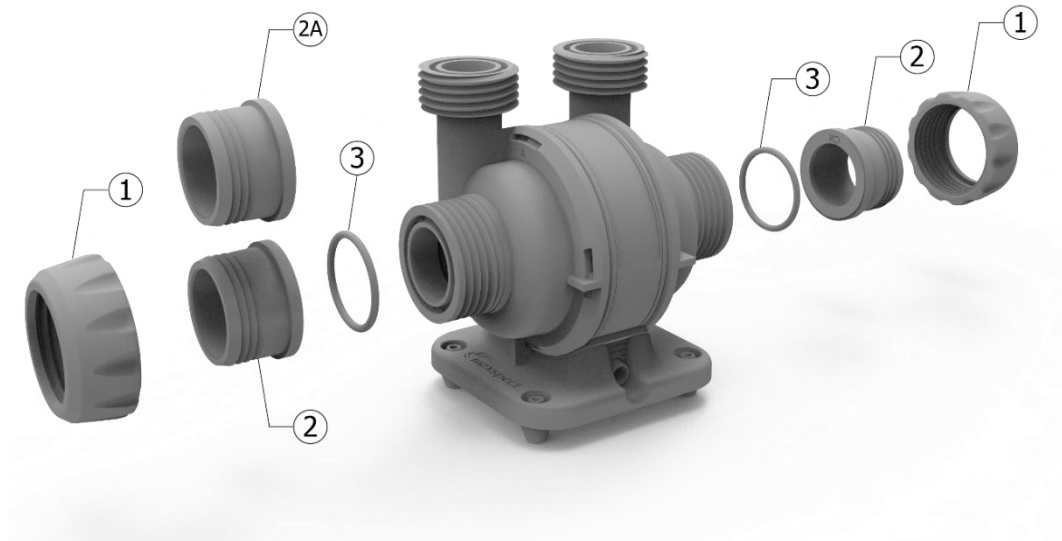

或當設備被用作上水泵時，進水口兩側可安裝過濾罩以避免異物進入泵體。

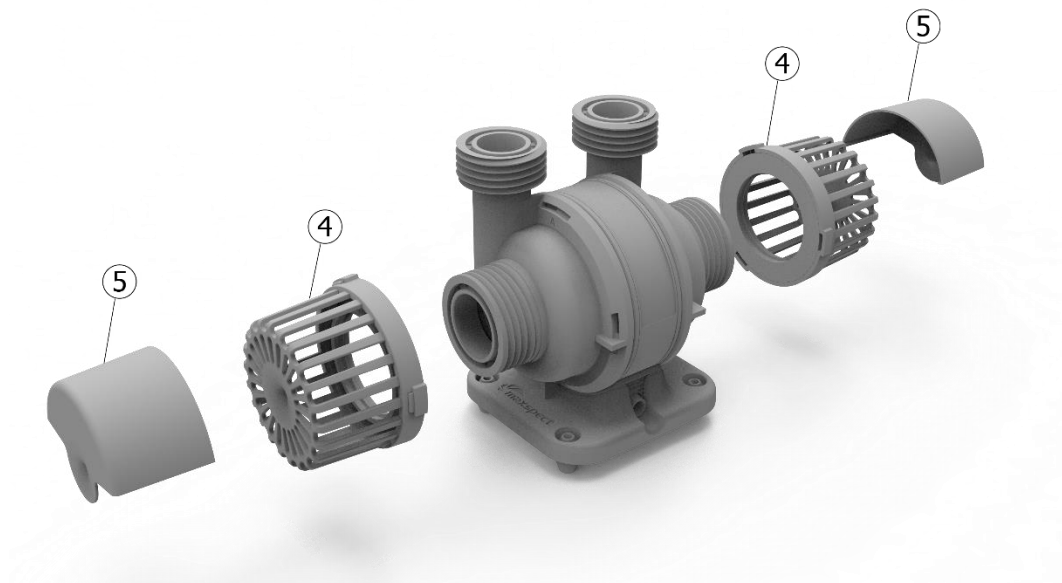

## 出水口安裝

**雙出水口：**可以使用 7、7A、7B 或 7C 號接頭來匹配不同尺寸的軟、硬水管。

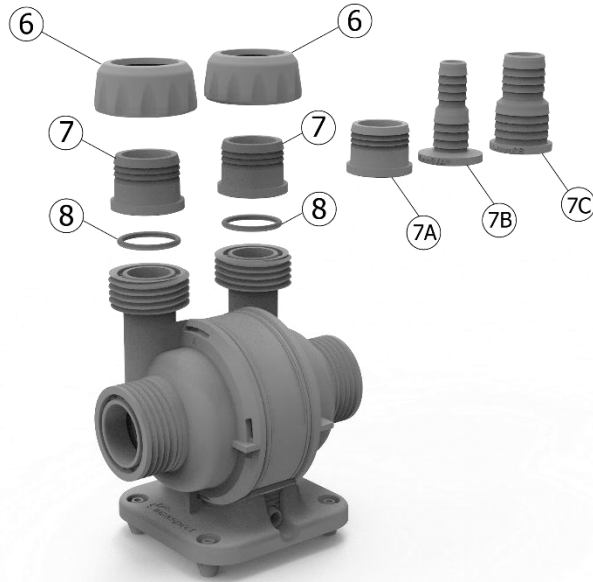

**二合一出水口：**可以使用 10、10A 或 10B 號接頭來匹配不同尺寸的軟、硬水管。

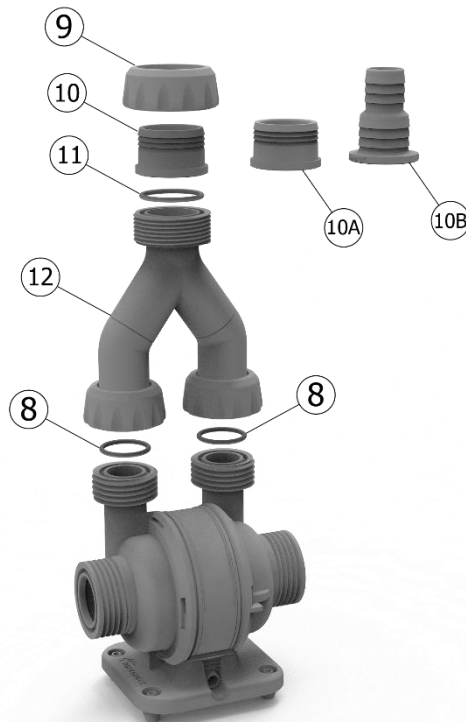

**單出水口：**可將泵體 B 側罩體和葉輪拆除，更換為泵蓋使之成為單出水口水泵。

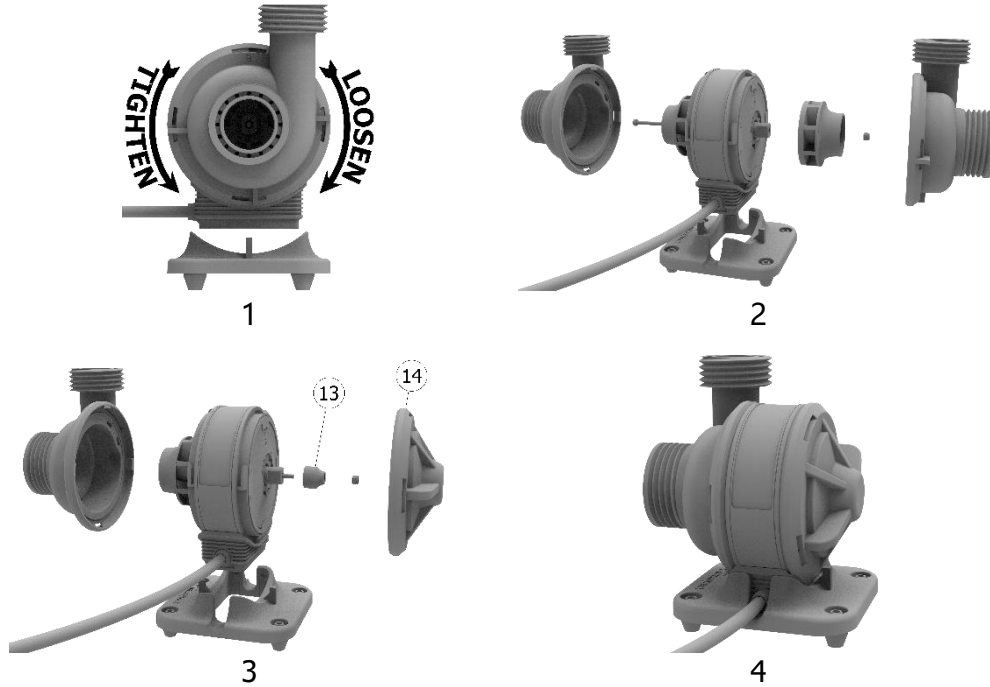

**提示：**只有 B 側泵罩可以更換為泵蓋；水泵運作前必須安裝底座。

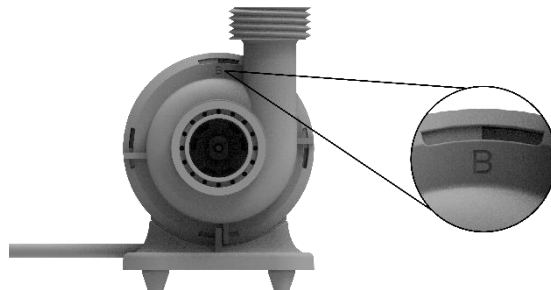

## 出水口方向

A 和 B 側的出水口均有三個方向可以調節。





## 控制器

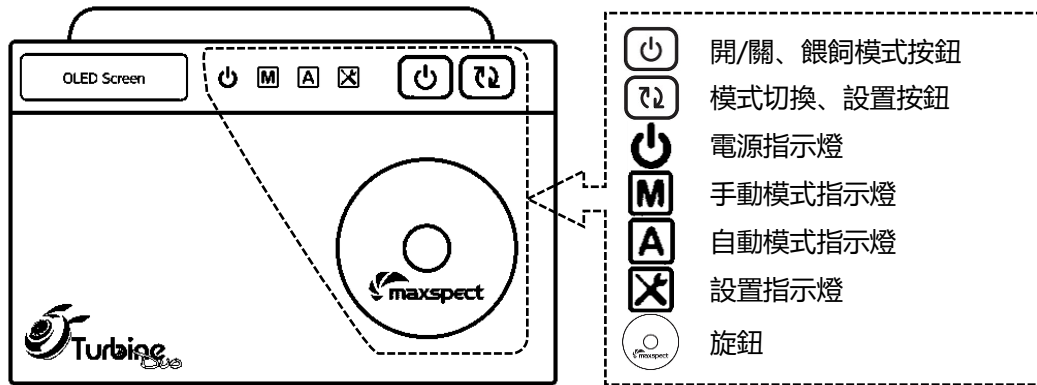

## 開、關設備

按住開關按鈕超過 4 秒可以停止設備。當設備停止時，泵體停止運轉，控制器顯示屏和指示燈會熄滅。如果設備連接了 ICV6(另售)，可通過 Syna-G App 激活設備。

## 初始化設備

使用設備前，需要對設備進行初始化設置。

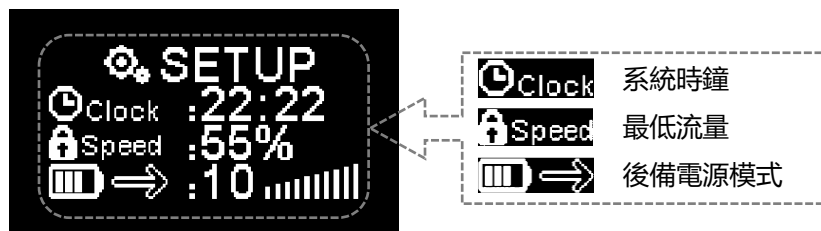





**系統時鐘：**將系統時鐘設置為用戶當地的時間。

**最低流量：**設置設備的最低流量。包括餵飼模式在內的所有水流模式，其可設置的最低流量均以此參數作為基礎開始計算。最低流量的可設置範圍是：1%-90%。

**後備電源模式：**設置設備工作在後備電源模式下的流量。隨設備附送的一條電源轉換線，它有兩個電源連接頭，一頭(DC12v)連接市電，一頭(DC24v)連接後備電源(用戶自行準備)，當市電被切斷時，電源轉換線將自動切換至後備電源供電。



1. 當 OLED 屏在激活的情況下，同時按動  和  按鈕可進入設置界面。
2. 按動  切換選項。
3. 旋轉  設置參數。
4. 按動  保存設置。



## 切換自動模式和手動模式

**手動模式:** 手動設置設備的水流模式和流量。

**自動模式:** 一組可以獨立設置水流模式和流量，並能夠 24 小時循環的設定。

手動模式主界面

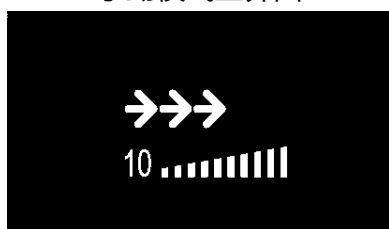

自動模式主界面

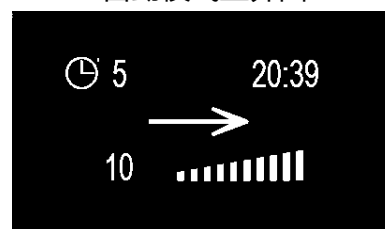

## 主界面功能介紹

主界面

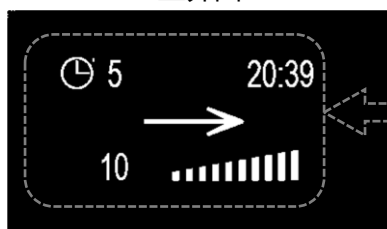

-  5 當前時間點
-  20:39 當前時間
-  水流模式
-  10 流量
-  流量指示計

設置界面

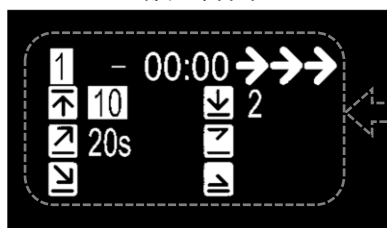

-  1 - 00:00 時間點(共 24 個)
-  水流模式
-  10 20s 2 參數變量

## OLED 顯示屏圖標說明

### 水流模式



恆速模式



隨機模式



快慢模式



進階快慢模式

### 變量參數



最高流量



最低流量



上升時長



下降時長



最高流量持續時長



最低流量持續時長

### 變量參數說明

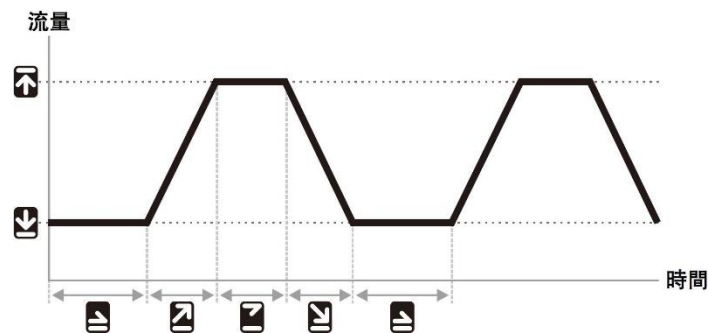

### 水流模式示例



恆速模式

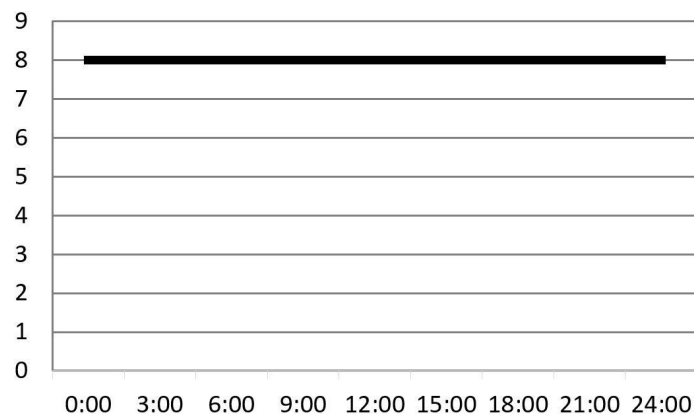

### 可設置參數

可設置流量範圍: 1-10 檔



8 檔



N/A



N/A



N/A



N/A



N/A

**→→→ 快慢模式**

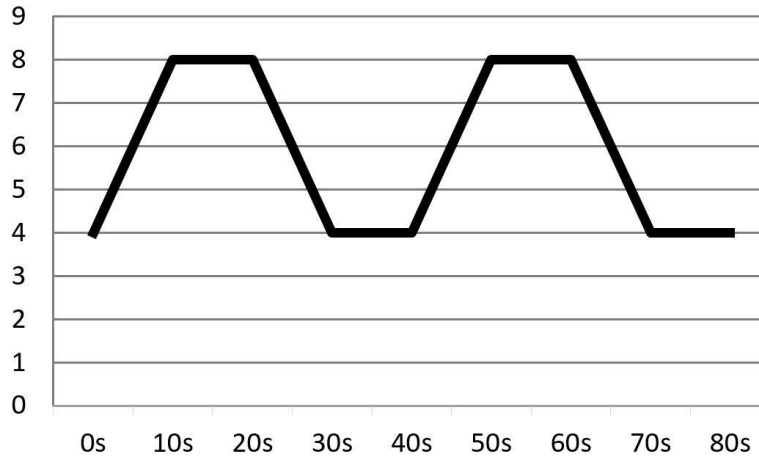

**可設置參數**

可設置流量範圍: 1-10 檔, 可設置時間範圍: 2-30 秒

	8 檔		10 秒		N/A			
	4 檔		N/A		N/A			
	=		=		=		=	10 秒

**→→→ 隨機模式**

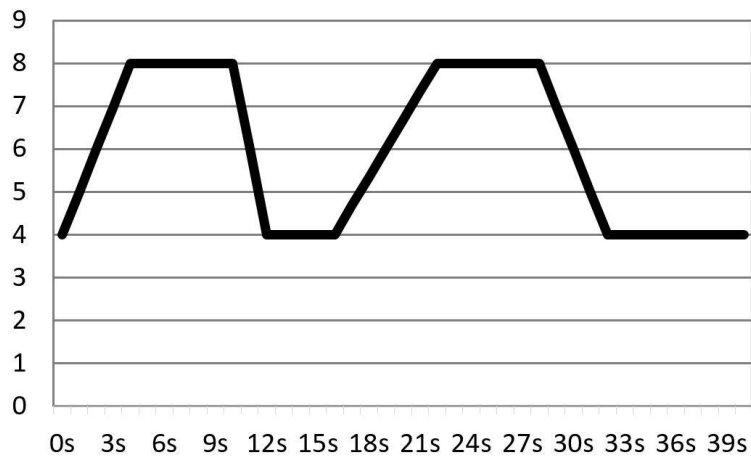

**可設置參數**

最大流量可設置範圍: 2-10 檔, 最小流量可設置範圍: 1-9 檔

	8 檔		N/A		N/A
	4 檔		N/A		N/A



## 進階快慢模式



### 可設置參數

可設置流量範圍: 1-10 檔, 可設置時間範圍: 2 秒-5 分鐘

	8 檔		2 秒		4 秒
	4 檔		8 秒		20 秒

### 手動模式

主界面

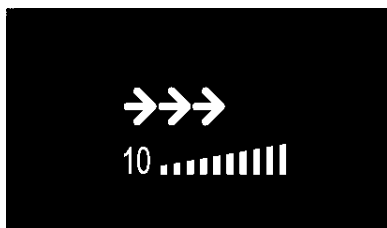

設置界面

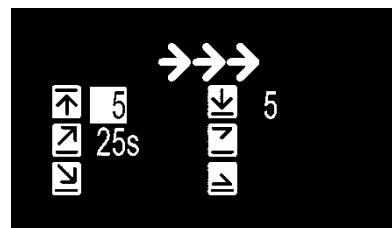

1. 按動  切換選項。
2. 旋轉  設置參數。
3. 按動  保存設置。

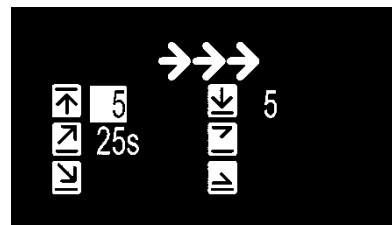

## 自動模式

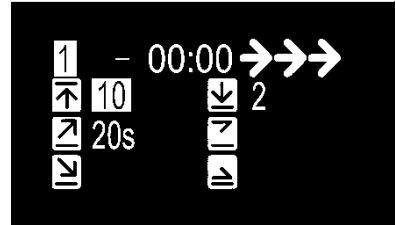
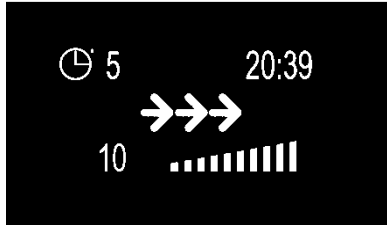

1. 按動  切換選項。
2. 旋轉  設置參數。
3. 按動  保存設置。

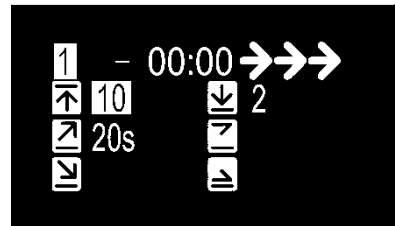

## 喂飼模式

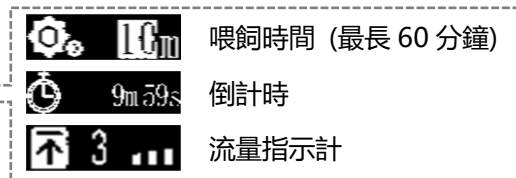

在任一主界面下按動  進入喂飼模式。

1. 按動  激活設置界面。
2. 按動  切換選項。
3. 旋轉  設置參數。
4. 按動  保存設置。

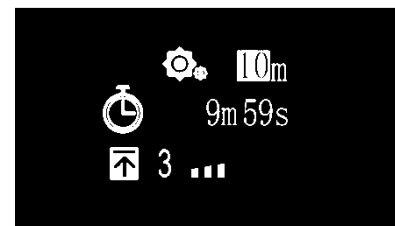

## 系統設定

系統設定包含一組基礎功能供用戶維護設備使用。

要進入系統設定界面，首先斷開設備電源，按住旋鈕，然後接通設備電源，直到屏幕顯示系統設定界面便可鬆開旋鈕。

系統設定包含 5 項功能：

1. 固件更新
2. 固件恢復
3. 恢復出廠設置
4. 系統測試
5. 型號選擇
6. 退出

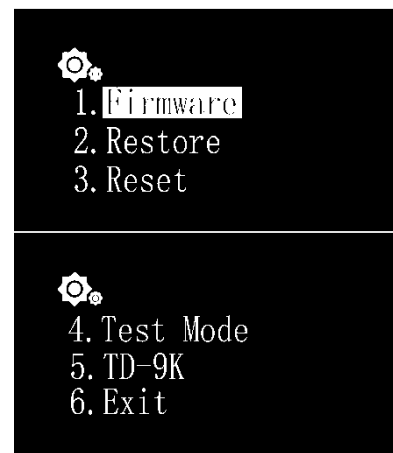

### 1. 固件更新

此功能用於更新系統固件。

1. 轉動  選擇 "Firmware"。
2. 按動  開始更新固件。

1. 當系統檢測不到 micro SD Card 或正確的固件文件時，屏幕會相應提示 "NO SD Card" 或 "Wrong File"。
2. 正常更新時屏幕會顯示更新進度。

當固件成功更新後，系統會自動重啟，新固件版本號會顯示在啟動界面中，更新固件不會影響用戶設定。



## 2. 固件恢复

此功能用於恢復出廠固件。當成功恢復後，系統會自動重啟，版本號會顯示在啟動界面中，恢復出廠固件不會影響用戶設定。

1. 轉動  選擇“Restore”。
2. 按動  開始恢復固件。



## 3. 恢復出廠設置

此功能用於恢復出廠設置。成功恢復後，系統會自動重啟。

1. 轉動  選擇“Reset”。
2. 按動  恢復出廠設置。



## 4. 系統測試

此功能用於系統檢測。用戶應在經銷商或售後服務人員的指導或授意下執行系統檢測操作。

## 5. 型號選擇

此功能用於設置設備型號，並且當設備和 Syna-G 系統連接時，作為設備名稱使用。正常情況下，用戶不應更改此項設定。

## 6. 退出

1. 轉動  選擇“Exit”。
2. 按動  退出系統設置。

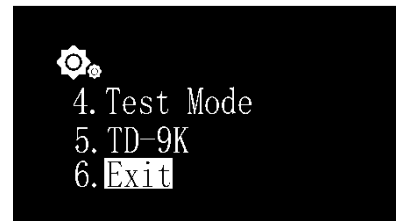



所有邁光品牌 (Maxspect) 產品自購買之日起 12 個月內若有質量問題，可享有 Maxspect 公司的保修服務。若在保修其內出現質量問題，Maxspect 公司將免費維修或更換配件。

若產品由於誤用，被改裝，發生事故，處理不當，或使用不當而受到損壞，或未經授權自行維修的，則不在保修範圍之內。不在保修範圍的情況包括但不限於，使用改裝配件和修改電路等被視為誤用或濫用而損壞產品的行為。

### **間接及附帶損害免費聲明:**

Maxspect 對您或其他使用者的間接或附帶損害不承擔責任。間接或附帶損害包括但不限於，使用產品造成的損失或不便，對個人財產造成的損失，如電話，收入損失或盈利損失。本質保書賦予您合法權利，在不同的地區您還可能享有其它權利。

除上面明確提出的內容外，Maxspect 公司對產品的質量，性能，適銷性或特別用途的適用性均沒有作出明示或暗示的擔保或陳述。因此，本產品“按現狀”提供，您作為購買者承擔有關此產品的質量和性能的全部風險。

在任何情況下，Maxspect 公司均不對因本產品或其文件的缺陷而引起的直接的、間接的、特別的、附帶的或結果性的損害承擔責任。

上述質保書，聲明和故障排除方法是唯一版本，沒有其它口頭的或書面的，明示的或暗示的內容。在任何時候，Maxspect 公司的經銷商，代理商或雇員都無權對此質保書進行更改、擴展或補充。

由於某些地區不允許此類附帶性或結果性損害的免責或有限責任，上述限制可能不適用於您。

**提示：**

有關產品規格等詳細信息，請瀏覽 Maxspect 官方網站：[www.maxspect.com](http://www.maxspect.com)







The background of the page is a complex, abstract geometric pattern composed of numerous overlapping, semi-transparent blue polygons of various shapes and sizes. The colors range from light sky blue to a deeper cerulean blue, creating a layered, crystalline effect. The overall impression is one of modern, technical precision.

**[www.maxspect.com](http://www.maxspect.com)**

NOTE: Products, packaging, features and specifications are subject to change.

All screen images are simulated.

© 2009-2017 Maxspect Limited. Reproduction in whole or in part without written permission is prohibited. All rights reserved. Maxspect is trademark of Maxspect Limited.

Maxspect™ Turbine Duo DC Pump Owner's Manual Version 1.0